



# **Agilent E4418B Power Meter**

## **User's Guide**



**Agilent Technologies**

# Notices

© Agilent Technologies, Inc. 1998–2013

No part of this manual may be reproduced in any form or by any means (including electronic storage and retrieval or translation into a foreign language) without prior agreement and written consent from Agilent Technologies, Inc. as governed by United States and international copyright laws.

## Manual Part Number

E4418-90032

## Edition

Eighth Edition, April 5, 2013

Printed in Malaysia

Agilent Technologies, Inc.  
3501 Stevens Creek Blvd.  
Santa Clara, CA 95052 USA

## Warranty

**The material contained in this document is provided “as is,” and is subject to being changed, without notice, in future editions. Further, to the maximum extent permitted by applicable law, Agilent disclaims all warranties, either express or implied, with regard to this manual and any information contained herein, including but not limited to the implied warranties of merchantability and fitness for a particular purpose. Agilent shall not be liable for errors or for incidental or consequential damages in connection with the furnishing, use, or performance of this document or of any information contained herein. Should Agilent and the user have a separate written agreement with warranty terms covering the material in this document that conflict with these terms, the warranty terms in the separate agreement shall control.**

## Technology Licenses

The hardware and/or software described in this document are furnished under a license and may be used or copied only in accordance with the terms of such license.

## Restricted Rights Legend

U.S. Government Restricted Rights. Software and technical data rights granted to the federal government include only those rights customarily provided to end user customers. Agilent provides this customary commercial license in Software and technical data pursuant to FAR 12.211 (Technical Data) and 12.212 (Computer Software) and, for the Department of Defense, DFARS 252.227-7015 (Technical Data - Commercial Items) and DFARS 227.7202-3 (Rights in Commercial Computer Software or Computer Software Documentation).

## Safety Notices

### CAUTION

A **CAUTION** notice denotes a hazard. It calls attention to an operating procedure, practice, or the like that, if not correctly performed or adhered to, could result in damage to the product or loss of important data. Do not proceed beyond a **CAUTION** notice until the indicated conditions are fully understood and met.

---

### WARNING

A **WARNING** notice denotes a hazard. It calls attention to an operating procedure, practice, or the like that, if not correctly performed or adhered to, could result in personal injury or death. Do not proceed beyond a **WARNING** notice until the indicated conditions are fully understood and met.

---

## Certification

Agilent Technologies certifies that this product met its published specifications at the time of shipment from the factory. Agilent Technologies further certifies that its calibration measurements are traceable to the United States National Institute of Standards and Technology, to the extent allowed by the Institute's calibration facility and to the calibration facilities of other International Standards Organization members.

## Warranty

This Agilent Technologies instrument product is warranted against defects in material and workmanship for a period of 3 years from date of shipment. During the warranty period, Agilent Technologies will at its option, either repair or replace products which prove to be defective. For warranty service or repair, this product must be returned to a service facility designated by Agilent Technologies. Buyer shall prepay shipping charges to Agilent Technologies and Agilent Technologies shall pay shipping charges, duties and taxes for products returned to Agilent Technologies from another country. Agilent Technologies warrants that its software and firmware designated by Agilent Technologies for use with an instrument will execute its programming instructions when properly installed on that instrument. Agilent Technologies does not warrant that the operation of the instrument or firmware will be uninterrupted or error free.

## Limitation of Warranty

The foregoing warranty shall not apply to defects resulting from improper or inadequate maintenance by Buyer, Buyer-supplied software or interfacing, unauthorized modification or misuse, operation outside of the environmental specifications for the product or improper site preparation or maintenance. NO OTHER WARRANTY IS EXPRESSED OR IMPLIED. AGILENT TECHNOLOGIES SPECIFICALLY DISCLAIMS THE IMPLIED WARRANTIES OF MERCHANTABILITY AND FITNESS FOR A PARTICULAR PURPOSE.

## Exclusive Remedies

THE REMEDIES PROVIDED HEREIN ARE BUYER'S SOLE AND EXCLUSIVE REMEDIES. AGILENT TECHNOLOGIES SHALL NOT BE LIABLE FOR ANY DIRECT, INDIRECT, SPECIAL, INCIDENTAL or CONSEQUENTIAL DAMAGES, WHETHER BASED ON CONTRACT, TORT or ANY OTHER LEGAL THEORY.

## Warnings and Cautions

This guide uses warnings and cautions to denote hazards.

### **WARNING**

**A warning calls attention to a procedure, practice or the like, which, if not correctly performed or adhered to, could result in injury or the loss of life. Do not proceed beyond a warning until the indicated conditions are fully understood and met.**

---

### **CAUTION**

A caution calls attention to a procedure, practice or the like which, if not correctly performed or adhered to, could result in damage to or the destruction of part or all of the equipment. Do not proceed beyond a caution until the indicated conditions are fully understood and met.

---

## Recommended Calibration Interval

Agilent Technologies recommends a two- years calibration cycle for the E4418B EPM Series power meter.

## Safety Symbols

The following symbol on the instrument and in the documentation indicates precautions that must be taken to maintain safe operation of the instrument.



Caution, risk of danger.  
The Instruction Documentation Symbol. The product is marked with this symbol when it is necessary for the user to refer to the instructions in the supplied documentation.



Alternating current (AC).



This symbol indicates the operating switch for 'Stand-by' mode. Note, the instrument is NOT isolated from the mains when the switch is pressed. To isolate the instrument, the mains coupler (mains input cord) should be removed from the power supply.



This symbol indicates the operating switch for 'On' mode).



External Protective Earth Terminal.  
While this is a Class I product, provided with a protective earthing conductor in a power cord, an external protective earthing terminal has also been provided. This terminal is for use where the earthing cannot be assured. At least an 18AWG earthing conductor should be used in such an instance, to ground the instrument to an assured earth terminal.

---

## Personal Safety Considerations

This is a Safety Class I product (provided with a protective earthing ground incorporated in the power cord). The mains plug shall only be inserted in a socket outlet provided with a protective earth contact. Any interruption of the protective conductor, inside or outside the instrument is likely to make the instrument dangerous. Intentional interruption is prohibited

### WARNING

**If this instrument is not used as specified, the protection provided by the equipment could be impaired. This instrument must be used in a normal condition (in which all means of protection are intact) only. No operator serviceable parts inside. Refer servicing to qualified personnel. To prevent electrical shock, do not remove covers. For continued protection against fire hazard, replace the line fuse(s) only with fuses of the same type and rating (for example, normal blow, time delay, etc.). The use of other fuses or material is prohibited.**

---

## General Safety Considerations

### WARNING

**Before this instrument is switched on, make sure it has been properly grounded through the protective conductor of the ac power cable to a socket outlet provided with protective earth contact. Any interruption of the protective (grounding) conductor, inside or outside the instrument or disconnection of the protective earth terminal can result in personal injury.**

---

### CAUTION

Any adjustments or service procedures that require operation of the instrument with protective covers removed should be performed only by trained service personnel.

---

## Regulatory Markings

---



The CE mark shows that the product complies with all the relevant European legal Directives (if accompanied by a year, it signifies when the design was proven).

---

**ICES/NMB-001**

This ISM device complies with Canadian ICES-001.  
Cet appareil ISM est conforme à la norme NMB-001 du Canada.

---

**ISM** GROUP 1  
CLASS A

This is the symbol of an Industrial Scientific and Medical Group 1 Class A product.

---



The CSA mark is a registered trademark of the Canadian Standards Association.

---

## IEC 1010-1 Compliance

This instrument has been designed and tested in accordance with IEC Publication 61010-1 +A1:1992 Safety Requirements for Electrical Equipment for Measurement, Control and Laboratory Use and has been supplied in a safe condition. The instruction documentation contains information and warnings which must be followed by the user to ensure safe operation and to maintain the instrument in a safe condition.

## Statement of Compliance

This product has been designed and tested for compliance with IEC 60529 (1989) Degrees of Protection Provided by Enclosures (IP Code). Level IPx4 is attained if, and only if, the carry case (Agilent Technologies part number 34141A) is fitted.

## User Environment

This product is designed for use in a sheltered environment (avoiding extreme weather conditions) in accordance with Pollution Degree 3 defined in IEC 60664-1, with the carry case (Agilent Technologies part number 34141A) fitted over the instrument.

The product is suitable for indoor use only, when this carry case is not fitted.

## Installation Instructions

To avoid unnecessary over-temperature conditions, while this carry case is fitted do not apply an ac mains supply voltage, only operate your Agilent Technologies E4418B from the battery pack.



## Regulatory Information

### Sound Emission

#### Herstellerbescheinigung

Diese Information steht im Zusammenhang mit den Anforderungen der Maschinenlarminformationsverordnung vom 18 Januar 1991.

- Sound Pressure LpA < 70 dB.
- Am Arbeitsplatz.
- Normaler Betrieb.
- Nach DIN 45635 T. 19 (Typprüfung).

#### Manufacturers Declaration

This statement is provided to comply with the requirements of the German Sound DIN 45635 T. 19 (Typprüfung).

- Sound Pressure LpA < 70 dB.
- At operator position.
- Normal operation.
- According to ISO 7779 (Type Test).

### Australian EMC Regulations



The C-Tick mark is a registered trademark of the Spectrum Management Agency of Australia. This signifies compliance with the Australian EMC Framework Regulations under the terms of the Radiocommunications Act of 1992.

## Declaration of Conformity (DoC)

The Declaration of Conformity (DoC) for this instrument is available on the Web site. You can search the DoC by its product model or description.

<http://regulations.corporate.agilent.com/DoC/search.htm>

### NOTE

If you are unable to search for the respective DoC, please contact your local Agilent representative.

---

## List of Related Publications

### The Agilent E4418B is also available in the following languages:

- English Language User's Guide - Option ABA
- German Language User's Guide - Option ABD
- Spanish Language User's Guide - Option ABE
- French Language User's Guide - Option ABF
- Italian Language User's Guide - Option ABZ
- Japanese Language User's Guide - Option ABJ

*Agilent Technologies E4418B/E4419B Programming Guide* (English language only) is also supplied with the above options except Option ABA. For Option ABA, the Programming Guide is available only by ordering Option 0BF.

*Agilent Technologies E4418B/E4419B Service Guide* is available by ordering Option 915.

*Agilent Technologies E4418B/E4419B CLIPs* (Component Location and Information Pack) is available by ordering E4418-90031.

Useful information on SCPI (Standard Commands for Programmable Instruments) can be found in:

- *A Beginner's Guide to SCPI*, which is available by ordering Agilent Technologies Part Number 5010-7166.
- The SCPI reference manuals which are available from:  
SCPI Consortium,  
8380 Hercules Drive, Suite P3,  
La Mesa, CA 91942, USA.  
Telephone: 619-697-4301  
Fax: 619-697-5955

## Agilent Technologies E4418B Options

The Agilent E4418B power meters have the following options available:

- Option 001, supplies an internal rechargeable battery providing full instrument functionality when access to an ac power outlet is not available.
- Option 002, supplies parallel rear panel sensor input(s). The power reference oscillator output is on the front panel.
- Option 003, supplies parallel rear panel sensor input(s). The power reference oscillator output is also on the rear panel.
- Option 004, deletes the Agilent 11730A sensor cable(s) provided.
- Option 0B0, deletes manual set.
- Option 908, provides rackmount kit for one instrument.
- Option 909, provides rackmount kit for two instruments.
- Option 915, provides the Agilent E4418B/E4419B Service Guide.
- Option 916, provides an additional Agilent E4418B User's Guide and Agilent E4418B/E4419B Programming Guide.
- Option 1BN, provides MIL-STD 45662A, Certificate of Calibration.
- Option 1BP, provides MIL-STD-45662A, Certificate of Calibration and data.

## Available Accessories

- Agilent 34161A accessory pouch
- Agilent 34141A yellow soft carry/operating case
- Agilent 34131A basic instrument transit case
- Agilent E9287A spare battery pack - for instruments fitted with option 001 only
- Agilent 34397A 12 Vdc to 115 Vac inverter (Option 0E3 230 V)
- The following Agilent power sensor cables are available:
  - Agilent 11730A 1.5 m (7.5 ft)
  - Agilent 11730B 3 m (10 ft)
  - Agilent 11730C 6.1 m (20 ft)
  - Agilent 11730D 15.2 m (50 ft)
  - Agilent 11730E 30.5 m (100 ft)
  - Agilent 11730F 61 m (200 ft)

## About this Guide

- 1 Getting Started** Chapter 1 This chapter prepares the power meter for use and helps you to get familiar with a few of the front panel features.
- 2 Power Meter Operation** Chapter 2 This chapter gives a detailed description of the capabilities and operation of the power meter. You will find this chapter useful when you are operating the power meter from the front panel.
- 3 Menu Reference** Chapter 3 This chapter details diagrammatically the menu maps for the power meter. It also gives a description of all the power meter's keys.
- 4 Error Messages** Chapter 4 This chapter lists the error messages that may appear as you are working with the power meter. Each description contains information to help you diagnose and solve the problem.
- 5 Specifications** Chapter 5 This chapter lists the power meter's specifications and describes how to interpret these specifications.

**THIS PAGE HAS BEEN INTENTIONALLY LEFT BLANK.**

# Contents

Certification	iii
Warranty	iii
Limitation of Warranty	iii
Exclusive Remedies	iv
Warnings and Cautions	iv
Safety Symbols	v
Personal Safety Considerations	vi
General Safety Considerations	vi
Regulatory Markings	vii
IEC 1010-1 Compliance	viii
Statement of Compliance	viii
User Environment	viii
Installation Instructions	viii
Regulatory Information	ix
List of Related Publications	xi
Agilent Technologies E4418B Options	xii
Available Accessories	xii
About this Guide	xiii

## 1 Getting Started

Introduction	2
Turning On the Power Meter	3
The Front Panel at a Glance	5
The Display Layout	8
Selecting Your Display Layout	11
Window Symbols	14
Warning Symbol	14
Confirmation Window	14
Wait Symbol	15
One of N Entry Window	15
Numeric or Alphanumeric Entry Window	15
The Rear Panel at a Glance	16
Adjusting the Carrying Handle	18
Rack Mounting the Power Meter	19

## 2 Power Meter Operation

Introduction	22
Battery Operation (Option 001)	24
General Information	24
Running Time	25
Charging Times	26
Backlight	26
Battery Removal/Replacement	27
Zeroing and Calibrating the Power Meter	29
Zeroing the Power Meter	29
Zero/Cal Lockout	29
Calibrating the Power Meter	30
Calibration Procedure Using Agilent E-Series Power Sensors and N8480 Series Power Sensors (excluding Option CFT)	30
Calibration Procedure using Agilent 8480 Series power sensors and N8480 Series Power Sensors with Option CFT	31
Zeroing and Calibrating Using TTL Inputs	35
Making Measurements with the Agilent E-Series Power Sensors and N8480 Series Power Sensors (excluding Option CFT)	39
Procedure	39
Making Measurements with the Agilent 8480 Series Power Sensors and N8480 Series Power Sensors with Option CFT	41
Procedure	41
Making Measurements using Sensor Calibration Tables	44
Selecting a Sensor Calibration Table	45
Making the Measurement	45
Editing Sensor Calibration Tables	46
Making Measurements using Frequency Dependent Offset Tables	53
Selecting a Frequency Dependent Offset Table	54
Making the Measurement	55
Editing Frequency Dependent Offset Tables	56
Setting the Units of Measurement	59
Selecting Units of Measurement from the Softkeys	60
Making Relative Measurements	61
Procedure	61
Setting the Resolution	62



Setting Offsets	63
Setting Channel Offsets	63
Setting Display Offsets	64
Setting Averaging	65
Step Detection	67
Measuring Pulsed Signals	68
Setting Measurement Limits	70
Setting Channel Limits	70
Setting Window Limits	72
Checking for Limit Failures	74
Selecting a Digital or Analog Display	76
Setting the Range	79
Configuring the Remote Interface	80
GPIB	80
RS232/RS422	81
Remote Interface Overview	83
Programming Language Selection	85
Recorder Output	86
Leveling a Source Output	87
Saving and Recalling Power Meter Configurations	88
How Measurements are Calculated	90
Presetting the Power Meter	91
Preset Conditions	91
Self Test	94
Power On Self Test	94
Front Panel Selection of Self Tests	95
Remote Testing	97
Test Descriptions	98
Operator Maintenance	101
Replacing the Power Line Fuse	101
Contacting Agilent Technologies	103
Before calling Agilent Technologies	103
Check the Basics	104
Instrument serial numbers	104
Sales and Service Offices	106

Returning Your Power Meter for Service 107

### **3 Menu Reference**

- Introduction 110
- The Front Panel Menu Maps 111
  - dBm/W Menu 111
  - Frequency/Cal Fac Menu 112
  - Meas Setup Menu 113
  - Rel/Offset Menu 114
  - Save/Recall Menu 114
  - System Inputs Menu (1 of 4) 115
  - System Inputs Menu (2 of 4) 116
  - System Inputs Menu (3 of 4) 117
  - System Inputs Menu (4 of 4) 118
  - Zero/Cal Menu 119
- Front Panel Menu Reference 120
  - Diagrammatical keys 142

### **4 Error Messages**

- Introduction 146
- Error Messages 148

### **5 Specifications**

- Introduction 156
- Power Meter Specifications 157
  - Meter 157
  - Accuracy 158
  - 1 mW Power Reference1 160
- Power Meter Supplemental Characteristics 161
  - Measurement Speed 161
  - Zero Drift of Sensors 161
  - Measurement Noise 162
  - Settling Time 165
  - Power Sensor Specifications 169
  - Battery Option 001 Operational Characteristics 170

General Characteristics	171
Rear Panel Connectors	171
Environmental Characteristics	172
General Conditions	172
Operating Environment	172
Storage Conditions	172
General	173
Dimensions	173
Weight	173
Safety	173
Remote Programming	174
Nonvolatile Memory	174

**THIS PAGE HAS BEEN INTENTIONALLY LEFT BLANK.**

## List of Figures

- Figure 2-1 Battery Status 25
- Figure 2-2 Battery Removal/Replacement 28
- Figure 2-3 Rmt I/O Port TTL Inputs 35
- Figure 2-1 Battery Status 25
- Figure 2-4 "Sensor Tbls" Screen 45
- Figure 2-5 "Edit Cal Screen" 47
- Figure 2-6 "Offset Tbls" Screen 54
- Figure 2-7 "Edit" Screen 56
- Figure 2-8 Effect of Offsets on a Channel Measurement 64
- Figure 2-9 Averaged Readings 66
- Figure 2-10 Pulsed Signal 68
- Figure 2-11 Limits Checking Application 71
- Figure 2-12 Limits Checking Results 71
- Figure 2-13 Remote I/O TTL Outputs 73
- Figure 2-14 Pass/Fail Limit Indicators 75
- Figure 2-15 Digital Display 76
- Figure 2-16 Analog Display 76
- Figure 2-17 Digital and Analog Display 76
- Figure 2-17 Digital and Analog Display 76
- Figure 2-18 RS232/ 422 Pin Assignment 81
- Figure 2-19 Interface Overview Examples 84
- Figure 2-20 Test Setup for Recording Swept Measurements 86
- Figure 2-21 "Save/Recall" Screen 89
- Figure 2-22 How Measurements are Calculated 90
- Figure 2-23 Replacing the fuse 102
- Figure 4-1 Error Annunciator Position 146

**THIS PAGE HAS BEEN INTENTIONALLY LEFT BLANK.**

## List of Tables

Table 1-1	Relevant Softkeys in Various Mode of Operation	10
Table 1-2	List of Possible Combinations for the Upper and Lower Display Lines	10
Table 2-1	Power Sensor Connection Requirements	33
Table 2-2	TTL Inputs Control Logic	35
Table 2-3	TTL Input Timing Diagram 1	36
Table 2-4	TTL Inputs Timing Diagram 2	37
Table 2-5	Measurement Units	59
Table 2-6	Range of Values for Window Limits	72
Table 3-1	Combination of Sensor Type and Correction Applied to Current Measurement	121
Table 5-1	Zero Set Specifications	158
Table 5-2	Noise Multiplier	162
Table 5-3	Power Sensor Specifications $\pm$	162
Table 5-4	Settling Time	165
Table 5-5	Settling Time	166
Table 5-6	Settling Time	168

**THIS PAGE HAS BEEN INTENTIONALLY LEFT BLANK.**





# 1 Getting Started

Introduction	2
Turning On the Power Meter	3
The Front Panel at a Glance	5
The Display Layout	8
Window Symbols	14
The Rear Panel at a Glance	16
Adjusting the Carrying Handle	18
Rack Mounting the Power Meter	19



## Introduction

One of the first things you will want to do with your power meter is to switch it on and become acquainted with its front panel. The sections in this chapter prepare the power meter for use and help you get familiar with some of the front panel operations.

The front panel consists of both keys and softkeys which allow you to select various functions and operations. When some keys are selected, the corresponding softkey labels are displayed on the power meter display.

If you are using the power meter remotely, refer to the *Agilent Technologies E4418B/4419B Programming Guide* for remote operating details.

### NOTE

The N8480 Series power sensors used in this user's guide is referring to all sensors from the N8480 Series unless otherwise stated.

---

## Turning On the Power Meter

The following steps show you how to turn on the power meter and verify that it is operating correctly.

- 1 Connect the power cord and turn on the power meter.

The front panel display and the green power LED light up when the power meter is switched on. The power meter performs its power on self test. If the self test is not successful, the error annunciator turns on. If this occurs, contact your Agilent Technologies Sales and Service office for instructions on returning the power meter to Agilent Technologies for service.

### CAUTION

This instrument is designed for use in Installation Category II and Pollution Degree 2 per IEC 1010 and 664 respectively.

---

### CAUTION

This instrument has an autoranging line voltage input, be sure the supply voltage is within the range of 85 to 264 Vac.



---

### NOTE

If the power meter has been stored at extremely low temperatures out of the operating range of the power meter, the display may take a few minutes to operate.

---

### 2 Set the display contrast if required.

The display contrast is adjusted by pressing  and . If these softkeys are not displayed, press  repeatedly until they appear.

### 3 Connect a power sensor.

Connect one end of the sensor cable to the power meter's channel input and the other end to the power sensor.

### 4 Making a measurement.

A minimum warm-up time of 30 minutes is recommended before accurate measurements can be made.

Prior to making your first measurement, you must zero and calibrate the sensor and meter combination. Refer to [Chapter 2](#) for further information if you are not familiar with zeroing, calibrating or making measurements with a power meter.

## The Front Panel at a Glance

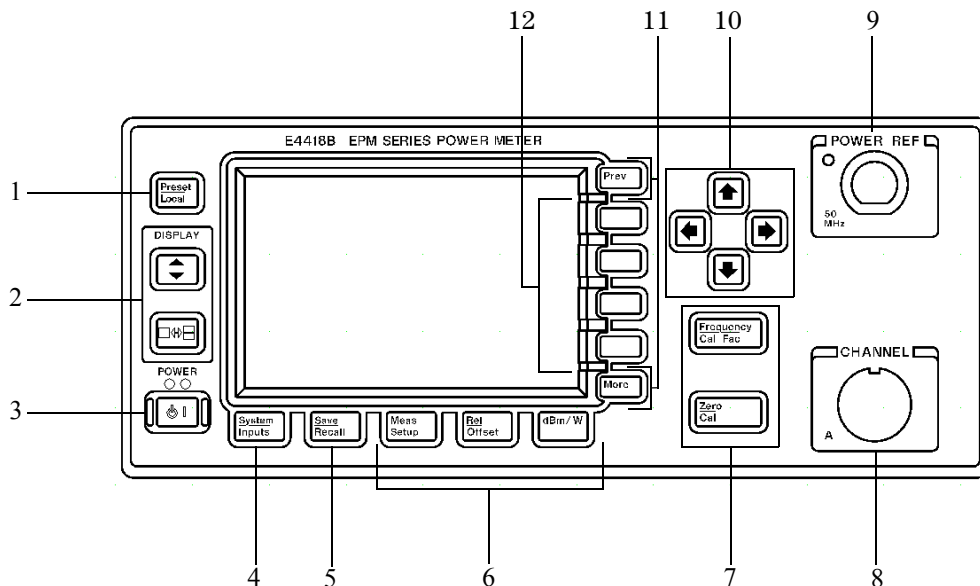

### 1 Preset Local

This key allows you to preset the power meter if you are currently working in local mode (that is, front panel operation). In local mode, a confirmation pop-up window is displayed prior to a preset being carried out. However, if you are in remote mode (that is, GPIB, RS232, or RS422 operation), then pressing this key places the power meter in local mode provided local lock out (LLO) is not enabled.

### 2 Keys relating to the display layout.



This key allows you to select the upper or lower measurement window on the power meter's display. The window which is selected is highlighted by a shadowed box. Any measurement setup you create is implemented in the selected window.



This key allows you to choose either a one or a two window display.



This key switches the power meter between on and standby. When the power meter is switched to standby (that is, when this key has not been selected but the line power is connected to the instrument) the red LED is lit. When the power meter is switched on, the green LED is lit.

Option 001 Battery: On standby with the battery installed and the AC power source disconnected, the red LED is off.

#### 4 “System/Inputs” key with softkey menu.

The  key allows access to softkey menus which affect the general power meter system setup, (for example the GPIB address) and also to softkey menus which effect the setup of the channel inputs. Refer to [Chapter 3](#) for further information about this key and its softkey menu.



This key is the only one that is completely dedicated to the control of the power meter as a system. The only other key which affects system parameters is the  key. Refer to [Chapter 3](#) for further information about this key and its softkey menu.

#### 6 Dedicated “Window” keys with softkey menus.



These keys allow access to softkey menus which affect the setup of the measurement windows. Refer to [Chapter 3](#) for further information about these keys and their softkey menus.

#### 7 Dedicated “Channel” keys with softkey menus.



These keys allow access to softkey menus which affect the measurement channel. Refer to [Chapter 3](#) for further information about these keys and their softkey menus.





#### 8 Channel Input.

The AGILENT E4418B has one sensor input. Power meters configured with Options 002 or 003 have the sensor inputs on the rear panel and the front panel.



#### 9 POWER REF Output.



The power reference output is a 50  $\Omega$  type-N connector. The output signal of 1 mW at 50 MHz is used for calibrating the sensor and meter combination. Power meters configured with Option 003 have the power reference on the rear panel.

**10 Arrow keys.**

, , , and  keys allow you to move the position of the cursor, select fields for editing and edit alphanumeric characters. Refer to [Chapter 3](#) for further information.

**11 Menu related keys.**

 This key allows you to move through all pages of a menu. The bottom right of the power meter display indicates the number of pages in the menu. For example, if “1 of 2” is displayed, pressing  moves you to “2 of 2”. Pressing  again moves you back to “1 of 2”.

 This key allows you to move back one level in the softkey menu. Repeatedly pressing  accesses a menu which allows you to increase and decrease the display contrast.

**12 Softkeys.**

These four keys are used to make a selection from the menus.

## The Display Layout

The following figure details the display layout when two measurement windows are displayed, one analog and one digital. However, it is possible using the  key to display just one measurement window.

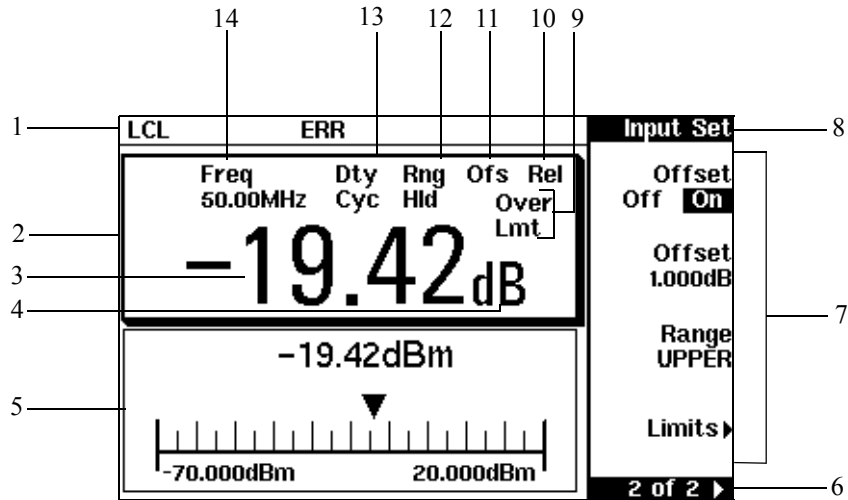



- 1 The status reporting line displays five fields, three associated with either GPIB, RS232, or RS422 status and two associated with error and warning conditions. The first field displays either “RMT” (remote, GPIB, RS232, or RS422 operation) or “LCL” (local, front panel operation).

For GPIB operation, the second field displays “TLK” if the power meter is addressed to talk or “LSN” if it is addressed to listen. The third field indicates an “SRQ” (service request).



For RS232 and RS422 operation, the second field displays “RX” when data is being received. The third field displays “TX” when the power meter is transmitting data.

The fourth field indicates “ERR” for any error conditions. The last field is used to report error and warning messages.

- 2 The measurement data is displayed in either one or two rectangular windows depending on the setting of . Pressing  allows you to toggle between a one or two window display.



When two windows are displayed and this key is pressed, the single window displayed is the one which was previously highlighted with the shadowed box. On the two window display, the measurement setup menus work on the window which is shadowed.

- 3 This is the measurement result field.
- 4 This field displays the units of measurement either dBm, dB, Watts, or %.
- 5 This window is configured to show an analog meter which displays the measurement result and the meter scaling.
- 6 This field displays the number of pages in the current softkey menu. For example, “1 of 2” indicates that there are two pages of softkeys and you are on the first page. Pressing  moves you to page “2 of 2”.
- 7 Any softkeys available are displayed in these four fields.
- 8 This field displays the title of the menu. For example, when the power meter is initially switched on, the “Contrast” menu is displayed and if you press  “Zero/Cal” is displayed.
- 9 This field indicates if the measurement result is out of the upper or lower limits set. If the measurement is within the limits, this field is empty. If the measurement result is less than the minimum limit set, “Undr Lmt” is displayed. If the measurement result is more than the maximum limit set, “Over Lmt” is displayed. Refer to [“Setting Measurement Limits”](#) on page 70 for further information.
- 10 This field displays “Rel” if relative mode is on. Refer to [“Making Relative Measurements”](#) on page 61 for further information.
- 11 This field displays “Ofs” if an offset is set. Refer to [“Setting Offsets”](#) on page 63 for further information.
- 12 This field displays “Rng Hld” if a range is selected. Refer to [“Setting the Range”](#) on page 79 for further information.
- 13 This field displays “Dty Cyc” if a duty cycle is set. This allows you to measure the power of a pulsed signal. Refer to [“Measuring Pulsed Signals”](#) on page 68 for further information.
- 14 The information in this field is displayed on two lines and depends on the combination of sensor type, sensor calibration table and frequency dependent offset table that are currently selected. [Table 1-1](#) shows all the possible combinations for the two lines of the display. Find the table entry which matches your display and use the reference number in the left-hand column to look up [Table 1-2](#) for the combination of sensor type and correction being applied to the current measurement.

For example, the display shows:

50MHz  
(10, C)

This is equivalent to reference number 4 in [Table 1-1](#) and when looked up in [Table 1-2](#) shows that:

- the sensor type is 8480 series
- a sensor calibration table is selected (10)
- a frequency dependent offset table is selected (C).

**Table 1-1** Relevant Softkeys in Various Mode of Operation

Reference Number	Upper Display Line	Lower Display Line
1	CF:xxx.x%	
2	CF:xxx.x%	xxx.xyHz(a)
3	xxx.xyHz	(nn)
4	xxx.xyHz	(nn,a)
5	xxx.xyHz	
6	xxx.xyHz	(a)
Where “y” is the frequency multiplier (M or G), “nn” is the sensor calibration table number and “a” is the frequency dependent offset table letter.		

**Table 1-2** List of Possible Combinations for the Upper and Lower Display Lines

Reference Number	Sensor Series	Sensor Correction	Frequency Dependent Offset Correction
1	8480 Series sensors/ N8480 Series sensors with Option CFT	Directly entered Calibration Factor	None
2			From offset table
3		Frequency dependent - from selected sensor calibration table	None
4			From offset table
5	E-Series sensors/ N8480 Series sensors (excluding Option CFT)	Frequency dependent - downloaded directly from sensor	None
6			From offset table

## Selecting Your Display Layout

Your power meter display is extremely flexible. It can be used to display a variety of different measurements and windows depending on your needs. The following diagram details the various options available to you.

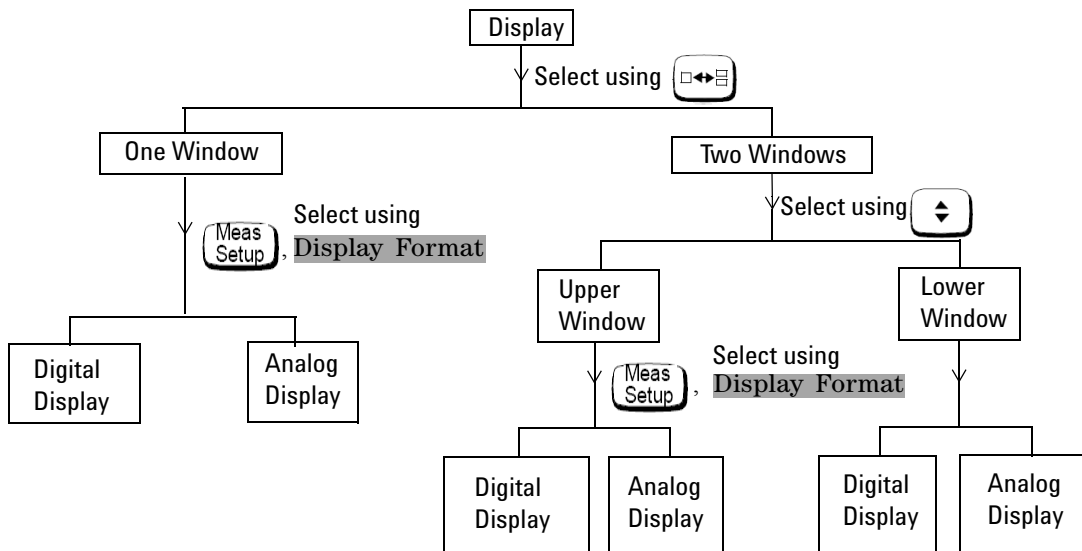

## Display Tutorial

If you wish to experiment with the display layout before you move on to make measurements, the following procedure guides you through a few of the display setups you can choose.

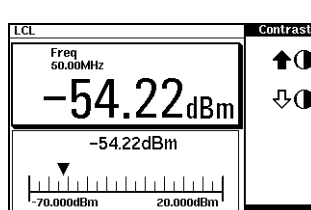

1 Press **Preset Local**, **Confirm**.

Notice that the upper window (which has a digital display) is the one which is highlighted by the dark box.

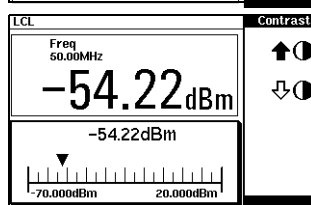

2 Press **Down Arrow**. The display remains the same apart from the fact that it is now the lower window (which is an analog display) that is highlighted by the dark box.

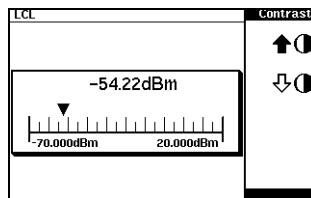

3 Press **Left Arrow**. The display now only shows the one window. This is the analog window which, in the previous step was selected with the **Down Arrow** key.

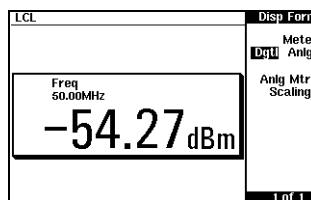

4 Press **Meas Setup**, **Display Format**, **Meter Dgtl Anlg** (Dgtl should be highlighted). The display shows a digital window.

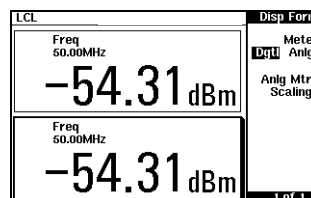

5 Press **Right Arrow**. The display now shows two digital windows.

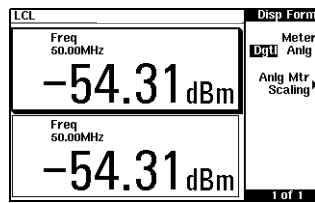

6 Press . The upper window is now the selected window and is highlighted by the black box.

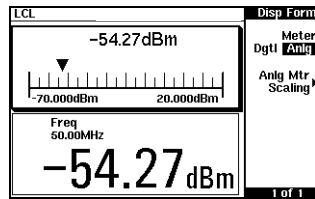

7 Press **Meter Dgtl Anlg** (Anlg should be highlighted). The upper window now displays an analog meter.

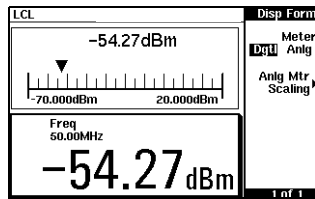

8 Select the digital display using .

## Window Symbols

There are a number of different graphic symbols and pop-up windows that can occur on the power meter display. These can occur for a variety of reasons such as when:

- an error or warning occurs.
- a confirmation is required.
- you are required to wait while the power meter carries out a procedure.
- you are required to select an entry from a list.
- you are required to enter an alphanumeric value.

### Warning Symbol

The warning symbol is displayed either directly in the measurement window or in a pop-up window when such an event occurs. A pop-up window is displayed for approximately two seconds. The text in the pop-up window gives details of the warning type. This symbol may also appear on a measurement window, for example, to indicate that a power sensor is not connected.



### Confirmation Window

This pop-up window is displayed when you are required to press **Confirm** to verify your previous selection. For example, prior to a preset being carried out.

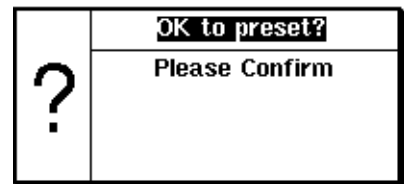



## Wait Symbol

The wait symbol is displayed when the power meter is carrying out a procedure, but no action is required from you. The symbol may appear directly in the measurement window or in a pop-up window. It may appear, for example, during zeroing or calibration.





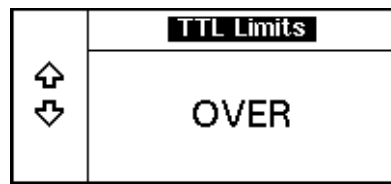

## One of N Entry Window

This pop-up window is displayed when you are required to select an entry using  and  from the list.



## Numeric or Alphanumeric Entry Window

This pop-up window is displayed when you are required to modify numeric or alphanumeric data. The  and  keys move the position of the cursor. The  and  keys increment and decrement the alphanumeric digit on which the cursor is currently positioned.

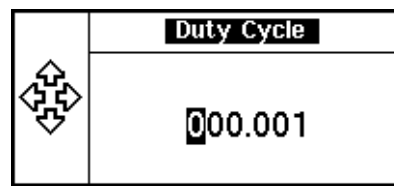

## The Rear Panel at a Glance

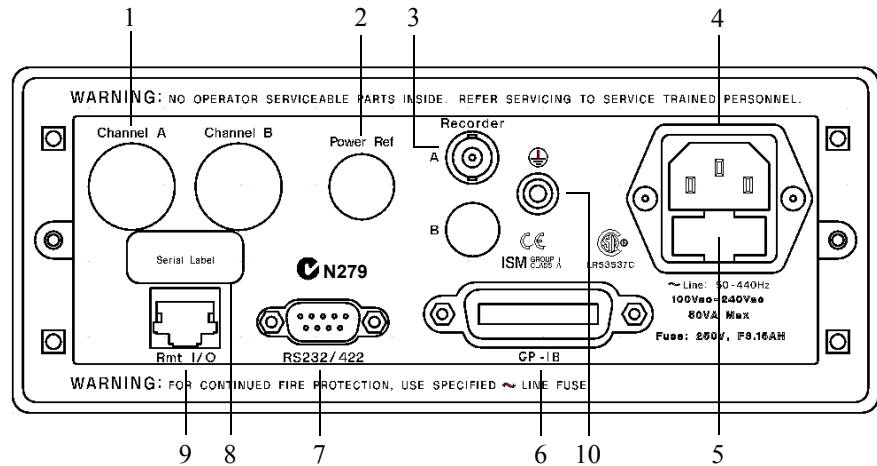

### 1 Channel A (Option 002 or 003 only)

### 2 Power Ref (Option 003 only)

The power reference output is a 50  $\Omega$  type-N connector. The output signal is used for calibrating the sensor meter combination.

### 3 Recorder Output

This output produces a DC voltage that corresponds to the power level of the channel input. Refer to “[Recorder Output](#)” on page 86 for further information.

### 4 Power socket

This power meter has an auto configuring power supply. This allows it to operate over a range of voltages without manually being set to a certain voltage.

### 5 Fuse

An F3.15AH fuse is installed for all voltage supplies.

### 6 GPIB

This connector allows the power meter to be controlled remotely using the General Purpose Interface Bus.

### 7 RS232/422

This connector allows the power meter to be controlled remotely using either the RS232 or RS422 serial interface standards.



**8 Serial Label**

Each power meter has its own individual identification number. Refer to “[Instrument serial numbers](#)” on page 104 for further information.

**9 Rmt I/O**

This connector is an RJ-45 series shielded modular jack assembly. It provides a TTL logic level output when a measurement exceeds a predetermined limit. TTL inputs are also provided to initiate zero and calibration cycles.

**10 Ground Connector**

Binding post, accepts 4 mm plug or bare wire connection.

## Adjusting the Carrying Handle

To adjust the position, grasp the handle by the sides and pull outward. Rotate the handle to the desired position.

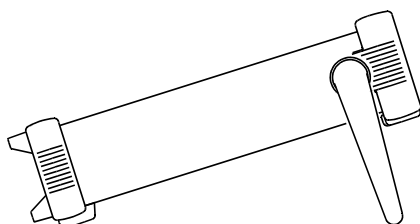
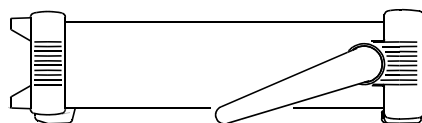

Bench top viewing positions

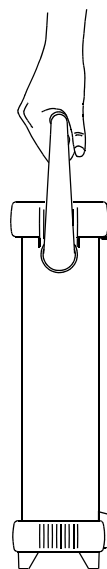

Carrying position

## Rack Mounting the Power Meter

You can mount the power meter in a standard 19-inch rack cabinet using one of three optional kits. Instructions and mounting hardware are included with each rack mounting kit. Any Agilent System II instrument can be rack mounted besides the Agilent E4418B power meter.

To rack mount the power meter:

- 1 Remove the handle by rotating it to the vertical position and pulling the ends outward.

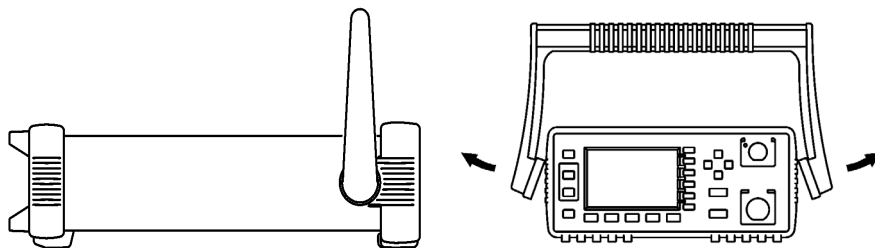

- 2 Remove the rubber bumper by stretching a corner and sliding it off.

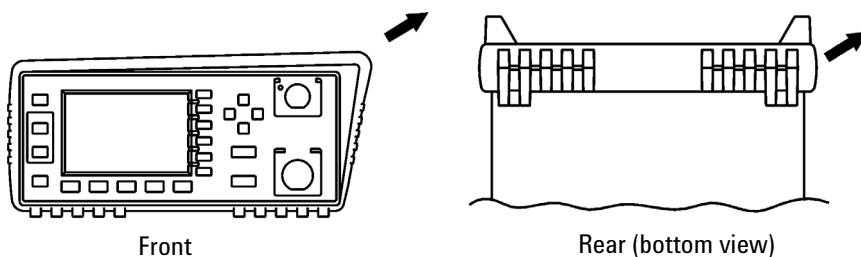

To rack mount a single instrument order Option 908 or adapter kit 5063-9240.

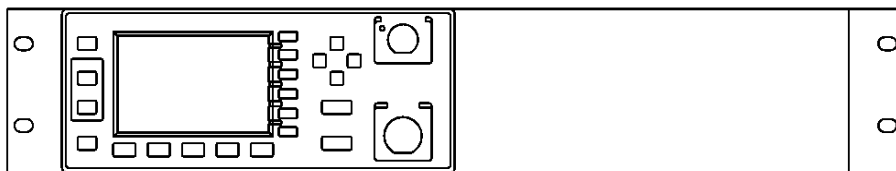

## 1 Getting Started

To rack mount two instruments side by side order Option 909 or lock-link kit 5061-9694 and flange kit 5063-9212.

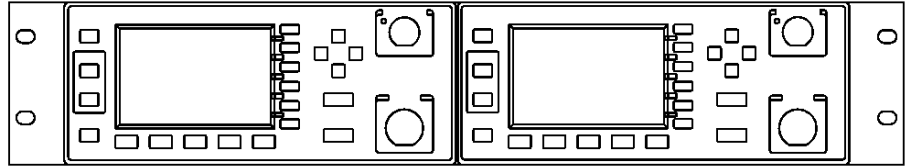

To install one or two instruments in a sliding support shelf order shelf 5063-9255 and slide kit 1494-0015 (for a single instrument, also order filler panel 5002-3999).

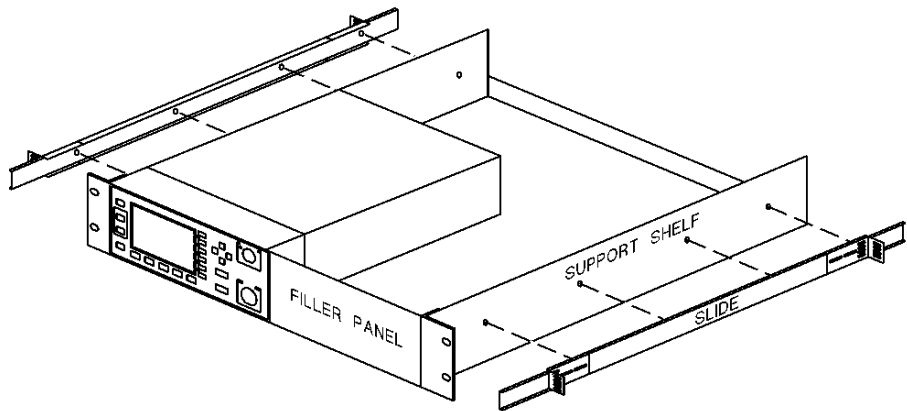

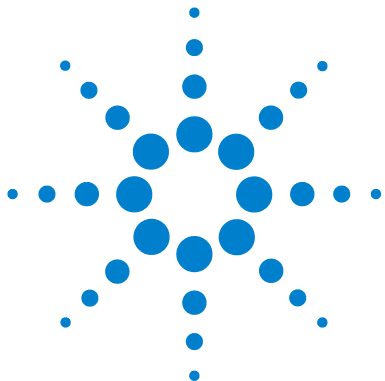

## 2 Power Meter Operation

Introduction	22
Battery Operation (Option 001)	24
Zeroing and Calibrating the Power Meter	29
Making Measurements with the Agilent E-Series Power Sensors and N8480 Series Power Sensors (excluding Option CFT)	39
Making Measurements with the Agilent 8480 Series Power Sensors and N8480 Series Power Sensors with Option CFT	41
Making Measurements using Sensor Calibration Tables	44
Making Measurements using Frequency Dependent Offset Tables	53
Setting the Units of Measurement	59
Selecting Units of Measurement from the Softkeys	60
Making Relative Measurements	61
Setting the Resolution	62
Setting Offsets	63
Setting Averaging	65
Measuring Pulsed Signals	68
Setting Measurement Limits	70
Selecting a Digital or Analog Display	76
Setting the Range	79
Configuring the Remote Interface	80
Recorder Output	86
Saving and Recalling Power Meter Configurations	88
How Measurements are Calculated	90
Presetting the Power Meter	91
Self Test	94
Operator Maintenance	101
Contacting Agilent Technologies	103



# Introduction

This chapter describes the parameters which configure the power meter to make measurements and help you determine settings to optimize performance. This chapter contains the following sections:

- “Battery Operation (Option 001)” on page 24
- “Zeroing and Calibrating the Power Meter” on page 29.
- “Calibrating the Power Meter” on page 30.
- “Making Measurements with the Agilent E-Series Power Sensors and N8480 Series Power Sensors (excluding Option CFT)” on page 39.
- “Making Measurements with the Agilent 8480 Series Power Sensors and N8480 Series Power Sensors with Option CFT” on page 41.
- “Making Measurements using Sensor Calibration Tables” on page 44.
- “Making Measurements using Frequency Dependent Offset Tables” on page 53
- “Setting the Units of Measurement” on page 59.
- “Selecting Units of Measurement from the Softkeys” on page 60.
- “Making Relative Measurements” on page 61.
- “Setting the Resolution” on page 62.
- “Setting Offsets” on page 63.
- “Setting Averaging” on page 65.
- “Measuring Pulsed Signals” on page 68.
- “Setting Measurement Limits” on page 70.
- “Selecting a Digital or Analog Display” on page 76.
- “Setting the Range” on page 79.
- “Configuring the Remote Interface” on page 80.
- “Recorder Output” on page 86.
- “Saving and Recalling Power Meter Configurations” on page 88.
- “How Measurements are Calculated” on page 90
- “Presetting the Power Meter” on page 91.
- “Self Test” on page 94.
- “Operator Maintenance” on page 101.

- “Contacting Agilent Technologies” on page 103.

# Battery Operation (Option 001)

The battery Option 001 allows the power meter to be used in operating environments where there is no convenient access to an AC power source.

## General Information

With the battery option installed and the power meter connected to an AC power source, the meter operates from the AC source and the battery runs in a controlled charge mode.

If the meter is powered up under battery power or if AC power is lost while connected to an AC source, a pop-up window displays the message “Running Under Battery Power”. When this screen is visible, the backlight mode (see “Backlight” on page 26) is over-ridden and the backlight is on continuously. Pressing the **Continue** softkey returns the display to the previous screen.

### Carry Case

A soft carry or operating case is available which makes it easy to transport and operate your power meter in installation and maintenance environments. To obtain a carry case, order Agilent part number 34141A.

### CAUTION

Do not attempt to recharge the power meter or operate the power meter from an AC power source while it is contained in the carry case.

---



## Running Time

A fully charged battery will typically allow the power meter to be used continuously for up to three hours with the backlight off and two hours with the backlight on.

### Battery Status

You can check the status of the battery by pressing **System Inputs**, **More**, **Service**, **More**, **Battery**. The Battery Status display (Figure 2-1) shows the charge condition of the battery represented on an analog meter scale. Below the analog scale is a message indicating the estimated power meter running time under battery operation with the present charge level.

Running time can be increased by operating the power meter with the display backlight turned off (see “Backlight” on page 26 ).

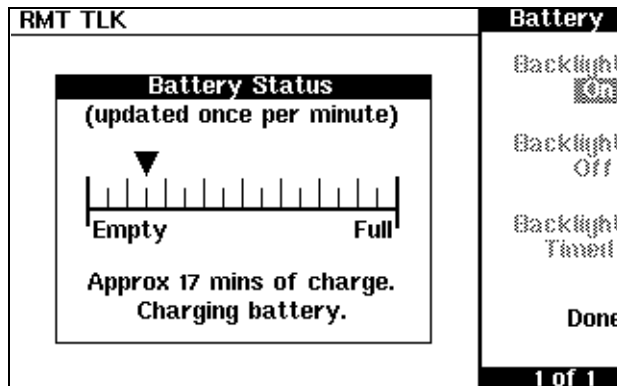

**Figure 2-1** Battery Status

When the power meter is running on battery power and there are less than 10 minutes of run-time remaining, the message “Battery Low” appears at the top of the screen. In addition, a pop-up window appears every minute with the message “Battery Power Low”.

### Charging Times

The battery charges automatically when the power meter is connected to an AC source. From an empty state, the battery is fully charged in less than two hours. After approximately 50 minutes, the battery has enough charge to enable one hour of operation with the backlight on. After approximately 35 minutes, the battery has enough charge to enable one hour of operation with the backlight off.

### Backlight

When you are operating the power meter under battery power, you can turn the display backlight off or on or set it to timed mode. In timed mode, the display backlight turns off 10 minutes after the last key press the display can be turned on again by pressing any key.

Working with the backlight off reduces the drain on the battery and increases the operating time available by approximately 50%. The display can be comfortably read in ambient daylight with the backlight off.

To access the backlight menu, press **System Inputs**, **More**, **Service**, **Battery**. Use the softkeys on the menu to select either **On**, **Off**, or **Timed**.

#### NOTE

If the power meter is connected to an AC power source the backlight menu is greyed out and the backlight is permanently on.

## Battery Removal/Replacement

The battery unit is easily removed and replaced. Follow the instructions given in [Figure 2-2](#). To obtain a replacement battery unit, order Agilent part number E9287A (this can only be used in power meters with Option 001 installed).

### WARNING

**This product uses a Nickel Metal Hydride battery.**

**Do not short circuit the battery terminals.**

**Do not subject the battery to excessive heat.**

**Do not dispose of by burning.**

**Refer to your local country regulatory requirements on the disposal of Nickel Metal Hydride batteries.**

---

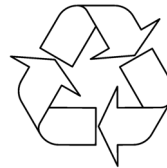
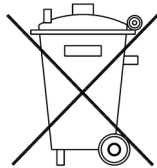

### CAUTION

Observe static precautions while removing and replacing the battery module.

---

## 2 Power Meter Operation

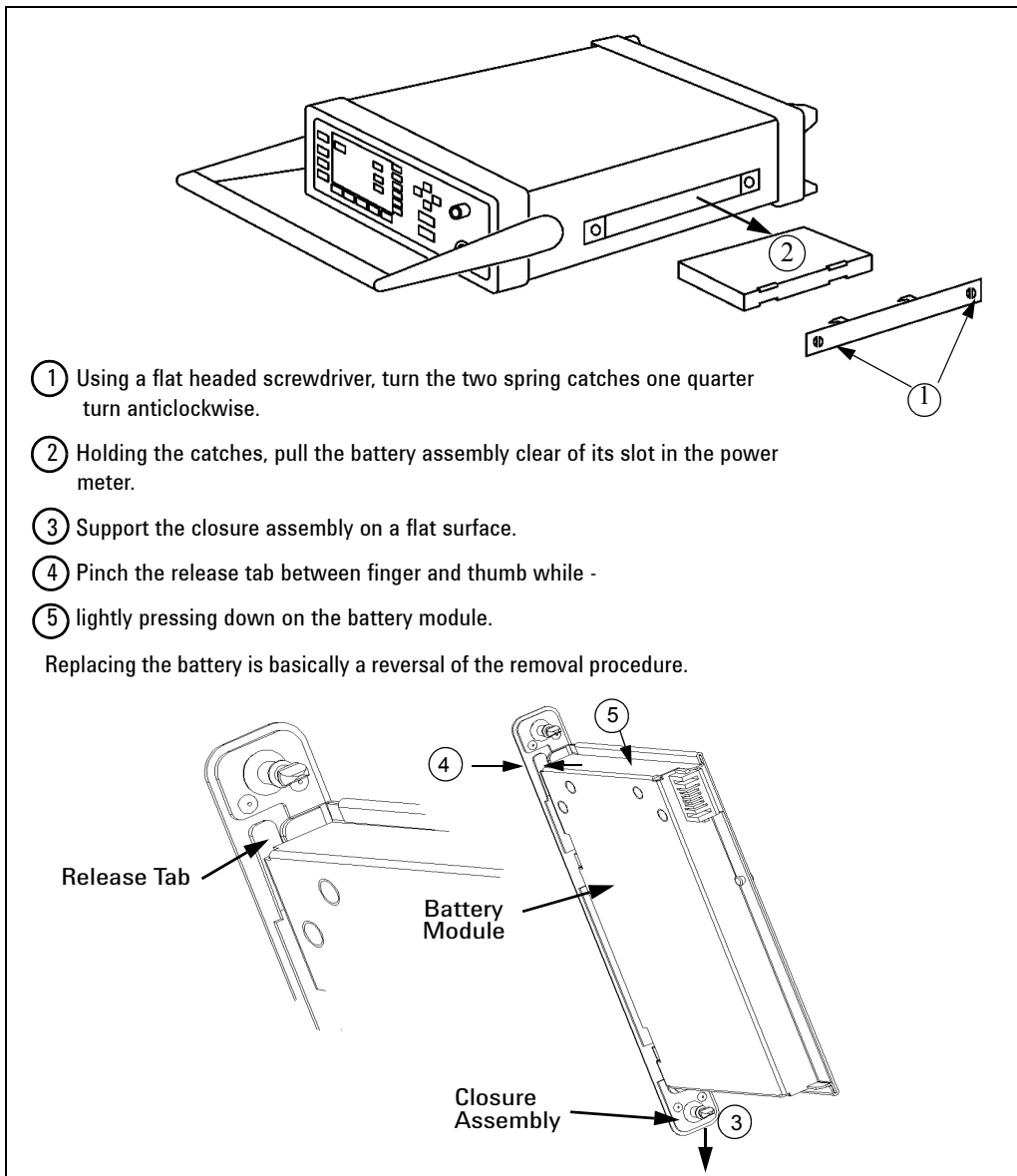

**Figure 2-2** Battery Removal/Replacement

## Zeroing and Calibrating the Power Meter

This section describes how to zero and calibrate the power meter. You should always zero the power meter prior to calibrating it.

### Zeroing the Power Meter

Zeroing adjusts the power meter for a zero power reading with no power applied to the power sensor. During zeroing, which takes approximately 10 seconds, the wait symbol is displayed.

To zero the power meter:

- 1 Press , **Zero**. During zeroing, the wait symbol is displayed.

#### When to Zero?

Zeroing of the power meter is recommended:

- when a 5 °C change in temperature occurs.
- when you change the power sensor.
- every 24 hours.
- prior to measuring low level signals. For example, 10 dB above the lowest specified power for your power sensor.

### Zero/Cal Lockout

The Zero/Cal Lockout facility provides a mean of ensuring that a measurement cannot be taken until the connected sensor has been zeroed and calibrated. If the Zero/Cal Lockout facility is enabled and a sensor is connected which have not been zeroed and calibrated, then the display window for the sensor will display the message “Please Zero + Cal ChA”.

If you zero the sensor before calibrating it, the message changes to “Please Cal ChA”.

If you calibrate the sensor before zeroing it, the message changes to “Please Zero ChA”.

The Zero/Cal Lockout facility can be enabled or disabled through either the System Inputs menu or the Zero Cal menu as follows:

Press **System Inputs**, **More**, **Must Cal**, **Off**, or **On**.

Press **Zero Cal**, **More**, **Must Cal**, **Off**, or **On**.

### Calibrating the Power Meter



Calibration sets the gain of the power meter using a 50 MHz 1 mW calibrator as a traceable power reference. The power meter's POWER REF output or a suitable external reference is used as the signal source for calibration. An essential part of calibrating is setting the correct reference calibration factor for the power sensor you are using. The *Agilent Technologies E4418B Series Power Meter User's Guide* require you to set the reference calibration factor. The Agilent E-Series power sensors and N8480 Series power sensors (excluding Option CFT) set the reference calibration factor automatically. During calibration, the wait symbol is displayed. Offset, relative, and duty cycle settings are ignored during calibration.

#### NOTE

During calibration, the power meter automatically switches the power reference calibrator on (if it is not already on), then after calibration, it switches it to the state it was in prior to the calibration.



### Calibration Procedure Using Agilent E-Series Power Sensors and N8480 Series Power Sensors (excluding Option CFT)

The following procedure describes how you calibrate the power meter with an Agilent E-Series power sensor or N8480 Series power sensor (excluding Option CFT). Since the power meter automatically downloads the Agilent E-Series power sensor or N8480 Series power sensor (excluding Option CFT)'s calibration table, there is no requirement to enter the reference calibration factor. The power meter identifies that an Agilent E-Series power sensor or N8480 Series power sensor (excluding Option CFT) is connected and will not allow you to select certain softkeys. The text on these softkeys appears grayed out.

- 1 Press  .
- 2 Connect the power sensor to the POWER REF output.
- 3 Press  to calibrate the power meter. During calibration the wait symbol is displayed. (The power meter automatically turns on the POWER REF output.)

### Example

To calibrate the power meter with an Agilent E-Series power sensor.

- Press  .
- Connect the power sensor to the POWER REF output.
- Press .

## Calibration Procedure using Agilent 8480 Series power sensors and N8480 Series Power Sensors with Option CFT

The following procedure describes how you calibrate the power meter with the Agilent 8480 Series power sensors and N8480 Series power sensors with Option CFT.





### NOTE

#### V8486A and W8486A sensors

For most 8480 Series sensors, the correct (A type or D type) linearity correction table is automatically selected. The linearity-type field on the measurement screen is grayed out. Under the gray-out condition, the selected linearity correction table that is displayed on the screen is irrelevant to the correct linearity correction table that is automatically selected by power meter firmware.

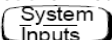

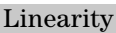

However, for the V8486A and W8486A sensors (**V8486A and W8486A sensors only**), the automatic selection must be overridden by selecting the D type linearity. Subsequent connection of another A type sensor while the D type is selected will result in a warning message stating that "Linearity Override May be Required".

To select the linearity type to be applied:

Press  ,  ,  ,  , or .





## 2 Power Meter Operation

There are a variety of methods to connect the power sensors to the power meter depending on the model of power sensor you are using. Refer to [Table 2-1](#) on page 33 for details on connecting different power sensor models.

- 1 Press .
- 2 Verify the reference calibration factor of your power sensor with that displayed under **Ref CF**. The value shown is obtained from the sensor calibration table if one is selected, otherwise it is the last value set or the default of 100%. If the value is not correct, press **Ref CF**. The power meter displays the reference calibration factor in a pop-up window. Modify this reference calibration factor (see below) as desired.
  - Use  or  to modify the digit on which the cursor is currently positioned.
  - Use  or  to move to other digits.
- 3 To confirm your choice, press **%**.
- 4 Connect the power sensor to the POWER REF output.
- 5 Press **Cal** to calibrate the power meter. During calibration, the wait symbol is displayed. (The power meter automatically turns on the POWER REF output.)

### Example

To calibrate the power meter with a power sensor whose reference calibration factor is 99.8%.

- Press .
- Press **Ref CF**. Use the , , , and  keys to enter 99.8. Press **%**.
- Connect the power sensor to the POWER REF output.
- Press **Cal**.



**Table 2-1** Power Sensor Connection Requirements

Sensor Model	Connection Requirements
Agilent 8481A Agilent 8481H Agilent 8482A Agilent 8482H Agilent N8481A Agilent N8481H Agilent N8482A Agilent N8482H Agilent E4412A Agilent E930xA Agilent E930xH Agilent E9304 H18 Agilent E9304 H19	These power sensors connect directly to the reference calibrator.
Agilent 8481D Agilent 8484A	Prior to the power meter being calibrated an Agilent 11708A 30 dB reference attenuator should be connected between the power sensor and the reference calibrator. Remove this attenuator from the power sensor input before making measurements.
Agilent 8483A	This power sensor requires a 75 $\Omega$ (f) to 50 $\Omega$ (m) N-Type adapter (1250-0597) to connect to the reference calibrator. Remove this adapter from the power sensor input before making measurements.
Agilent R8486A Agilent Q8486A Agilent V8486A Agilent W8486A Agilent R8486D Agilent Q8486D Agilent N8486AR Agilent N8486AQ	The waveguide power sensors have two connectors. The N-Type connector is the one which is used to calibrate the power meter.
Agilent 8481B Agilent N8481B Agilent 8482B Agilent N8482B Agilent E930xB	These power sensors are configured with an attenuator. Prior to the power meter being calibrated, this attenuator must be removed. The attenuator must be reconnected prior to making measurements.
Agilent 8485A Agilent N8485A Agilent E4413A Agilent E9300A H24 Agilent E9300A H25	This power sensor requires an APC 3.5 (f) to 50 $\Omega$ (m) N-Type adapter (08485-60005) to connect to the reference calibrator. Remove this adapter before making measurements.

## 2 Power Meter Operation

Sensor Model	Connection Requirements
Agilent 8485D	Prior to the power meter being zeroed and calibrated, an Agilent 11708A 30 dB reference attenuator and an APC 3.5 (f) to 50 $\Omega$ (m) N-Type adapter (08485-60005) should be connected between the power sensor and the reference calibrator. Remove this attenuator from the power sensor input before making measurements.
Agilent 8487A Agilent N8487A Agilent N8488A	This power sensor requires an APC 2.4 (f) to 50 $\Omega$ (m) N-Type adapter (08487-60001) to connect to the power meter. Remove this attenuator before making measurements.
Agilent 8487D	Prior to the power meter being zeroed and calibrated, an Agilent 11708A 30 dB reference attenuator and an APC 2.4 (f) to 50 $\Omega$ (m) N-Type adapter (08487-60001) should be connected between the power sensor and the reference calibrator. Remove this attenuator from the power sensor input before making measurements.

## Zeroing and Calibrating Using TTL Inputs

You can use the TTL inputs on the rear panel Rmt I/O port to initiate zero and calibration cycles on the power meter. The connector is an RJ-45 Series shielded modular jack with the TTL input pins connected as shown in [Figure 2-3](#).

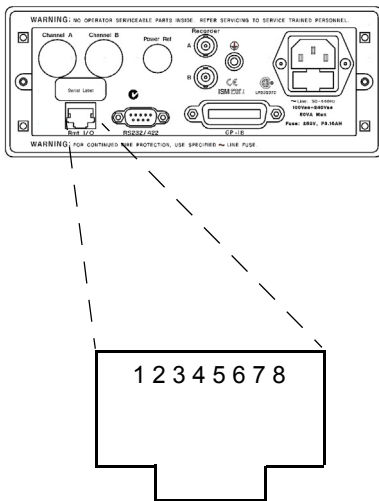

Pin Number	Connection
1	none
2	Ground
3	Upper Window TTL Output
4	Lower Window TTL Output
5	TTL Input 1
6	TTL Input 2
7	Ground
8	Ground

**Figure 2-3** Rmt I/O Port TTL Inputs

The TTL inputs are active low and control the zero and calibration functions as shown in [Table 2-2](#)

**Table 2-2** TTL Inputs Control Logic

Input 1	Input 2	Operation
1	1	None
1	0	CAL
0	1	ZERO
0	0	CAL

## 2 Power Meter Operation

Effective control of the zero and calibration cycles using the TTL inputs depends on correct timing of the input signals as shown in [Table 2-3](#) and [Table 2-4](#).

**Table 2-3** TTL Input Timing Diagram 1

Time	Description	Value
T1	Minimum width of input	300 ms
T2	Time between input detection and start of zero/cal cycle. This is determined by the number of averages x sample rate or if there is an existing zero/cal operation in progress, the time for this current operation to complete. Note that the worst case is 1024 averages x 50 ms = 51.2 s. For front panel operation (in free run mode) the time is 1 x 50 ms.	Max: 50 ms (typical) Min: 0 ms
T3	Maximum width of input. Longer inputs may cause a subsequent zero/cal operation some time after the current one is complete.	4 s

**Table 2-3** TTL Input Timing Diagram 1

T4	Time for zero/cal operation to complete.	Zero: 10 s (8480 Series) 12 s (E-Series) 20 s (N8480 Series exclude Option CFT) 8 s (N8480 Series with Option CFT) Cal: 6 s (8480 Series) 7 s (E-Series) 9 s (N8480 Series exclude Option CFT) 6 s (N8480 Series with Option CFT)
All timings based on 100 ms firmware polling.		

**Table 2-4** TTL Inputs Timing Diagram 2

Timing of zero/cal inputs for condition "00".		
Time	Description	Value
T5	Maximum time between inputs going low.	100 ms
T6	Minimum overlap of low inputs.	200 ms

## 2 Power Meter Operation

**Table 2-4** TTL Inputs Timing Diagram 2

T7	Time between input detection and start of zero/cal cycle. This is determined by the number of averages x sample rate or if there is an existing zero/cal operation in progress, the time for this current operation to complete. Note that the worst case is 1024 averages x 50 ms = 51.2 s. For front panel operation (in free run mode) the time is 1 x 50 ms.	4 s
T8	Time for cal operation to complete.	Cal: 6 s (8480 Series) 7 s (E-Series) 9 s (N8480 Series exclude Option CFT) 6 s (N8480 Series with Option CFT)
All timings based on 100 ms firmware polling. If both TTL inputs are simultaneously low under any circumstances other than those shown above, the operation is undefined.		

## Making Measurements with the Agilent E-Series Power Sensors and N8480 Series Power Sensors (excluding Option CFT)





This section describes how to make continuous wave measurements using the Agilent E-Series power sensors and N8480 Series power sensors (excluding Option CFT). The Agilent E-Series power sensors and N8480 Series power sensors (excluding Option CFT) have their sensor calibration tables stored in EEPROM. This allows the frequency and calibration data to be downloaded to the power meter automatically.

To make measurements, perform the following steps:



- 1 Zero and calibrate the power meter.
- 2 Set the frequency for the signal you want to measure.
- 3 Take a reading.

### Procedure

The following procedure details how to make a measurement on channel A of the power meter.







- 1 Ensure that no power is applied to the power sensor.
- 2 Press  .
- 3 Press **Zero**. During zeroing, which takes approximately 10 seconds, the wait symbol is displayed.
- 4 Connect the power sensor to the POWER REF output.
- 5 Press **Cal** to calibrate the power meter. During calibration, the wait symbol is displayed. (The power meter automatically turns on the POWER REF output.)
- 6 Press  . The current setting of the frequency is displayed under the **Freq** softkey.
- 7 To change this setting, press **Freq**. The power meter displays the frequency in a pop-up window. Modify this frequency (see below) as desired.
  - Use  or  to modify the digit on which the cursor is currently positioned.

## 2 Power Meter Operation

- Use  or  to move to other digits.
- 8 To confirm your choice, press the appropriate frequency units.
  - 9 Connect the power sensor to the signal to be measured.
  - 10 The measurement result is now displayed.

### Example

To make a measurement using an Agilent E-Series power sensor. The frequency of the signal to be measured is 100 MHz.

- Disconnect the power sensor from any source.
- Press .
- Press **Zero**.
- Connect the power sensor to the POWER REF output.
- Press **Cal**.
- Press , **Freq**. Use the , , , and  keys to enter 100. Press **MHz**.
- Connect the power sensor to the signal to be measured.
- The measurement result is now displayed.



## Making Measurements with the Agilent 8480 Series Power Sensors and N8480 Series Power Sensors with Option CFT

This section applies to all Agilent 8480 Series power sensors and N8480 Series power sensors with Option CFT. It does not apply to the Agilent E-Series power sensors and N8480 Series power sensors (excluding Option CFT) .

For the Agilent 8480 Series power sensors and N8480 Series power sensors with Option CFT, there are two methods of providing correction data to the power meter:

- a inputting the individual calibration factor for a frequency prior to making the measurement, or
- b using sensor calibration tables.

This section describes how to make measurements without using sensor calibration tables, that is inputting the individual calibration factor for a frequency prior to making the measurement. This method is advantageous if you are only measuring at one frequency, as entering all the calibration data in this instance is not required.

To make measurements without sensor calibration tables, perform the following steps:









- 1 Zero and calibrate the power meter. Before carrying out the calibration, you must set the reference calibration factor of the power sensor.
- 2 Set the calibration factor value for the frequency of the signal you want to measure.
- 3 Take a reading.

### Procedure

The following procedure details how to make a measurement on channel A.

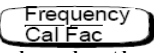











- 1 Ensure that no power is applied to the power sensor.
- 2 Press  .
- 3 Press **Zero**. During zeroing, which takes approximately 10 seconds, the wait symbol is displayed.
- 4 Connect the power sensor to the POWER REF output.

## 2 Power Meter Operation

- 5 The current setting of the reference calibration factor is displayed under the **Ref CF** softkey. To change this setting, press **Ref CF**. The power meter displays the reference calibration factor in a pop-up window. Modify this reference calibration factor (see below) as desired.
  - Use  or  to modify the digit on which the cursor is currently positioned.
  - Use  or  to move to other digits.
- 6 To confirm your choice, press **%**.
- 7 Press **Cal** to calibrate the power meter. During calibration, the wait symbol is displayed. (The power meter automatically turns on the POWER REF output.)
- 8 Press . The current setting of the calibration factor is displayed under the **Cal Fac** softkey. To change this setting, press **Cal Fac**. The power meter displays the calibration factor in a pop-up window. Modify this calibration factor (see below) as desired.
  - Use  or  to modify the digit on which the cursor is currently positioned.
  - Use  or  to move to other digits.
- 9 To confirm your choice, press **%**.
- 10 Connect the power sensor to the signal to be measured.
- 11 The measurement result is now displayed.

### Example

To make a measurement on channel A with a power sensor which has a reference calibration factor of 99.8% and a calibration factor of 97.8% at the measurement frequency.

- Disconnect the power sensor from any source.
- Press  .
- Press **Zero**.
- Press **Ref CF**. Use the , , , and  keys to enter 99.8. Press .
- Connect the power sensor to the POWER REF output.
- Press **Cal**.
- Press , **Cal Fac**. Use the , , , and  keys to enter 97.8. Press .
- Connect the power sensor to the signal to be measured.
- The measurement result is now displayed.

# Making Measurements using Sensor Calibration Tables

This section applies to all Agilent 8480 Series power sensors and N8480 Series power sensors with Option CFT. It does not apply to the Agilent E-Series power sensors and N8480 Series power sensors (excluding Option CFT) .

For the Agilent 8480 Series power sensors and N8480 Series power sensors with Option CFT, there are two methods of providing correction data to the power meter:

- a inputting the individual calibration factor for a frequency prior to making the measurement, or
- b using sensor calibration tables.

This section describes how to use sensor calibration tables. Sensor calibration tables are used to store the measurement calibration factors, supplied with each power sensor in the power meter. These calibration factors are used to correct measurement results.

Using sensor calibration tables provides you with a quick and convenient method for making power measurements over a range of frequencies using one or more power sensors. The power meter is capable of storing 20 sensor calibration tables of 80 frequency points each.

To use sensor calibration tables you:

- 1 Select the table to work on a channel. Refer to [“Selecting a Sensor Calibration Table”](#) on page 45 for further information. If you are required to edit the table, refer to [“Editing Sensor Calibration Tables”](#) on page 46 for further information.
- 2 Zero and calibrate the power meter. The reference calibration factor used during the calibration is automatically set by the power meter from the sensor calibration table.
- 3 Specify the frequency of the signal you want to measure. The calibration factor is automatically set by the power meter from the sensor calibration table. Refer to [“Making the Measurement”](#) on page 45 for further information.
- 4 Make the measurement.

## Selecting a Sensor Calibration Table

You can select a sensor calibration table for use by pressing **System Inputs**, **Tables**, **Sensor Cal Tables**, **Table Off On**. The “State” field indicates if any sensor calibration tables are currently selected. The “Sensor Tbls” screen is displayed as shown in [Figure 2-4](#).

RMT TLK			Sensor Tbls
Tbl	Name	State Pts	Edit Table
0	<b>DEFAULT</b>	off 2	
1	HP8481A	off 19	
2	HP8482A	off 12	Table Off On
3	HP8483A	off 10	
4	HP8481D	off 21	
5	HP8485A	off 22	
6	R8486A	off 17	
7	Q8486A	off 19	
8	R8486D	off 17	Done
9	HP8487A	off 54	
			1 of 1

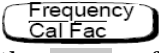



Figure 2-4 “Sensor Tbls” Screen

## Making the Measurement

To make the power measurement, you zero and calibrate the power meter, then set it for the frequency of the signal you want to measure. The power meter automatically selects the calibration factor from the sensor calibration table.

- 1 Press **Zero Cal**.
- 2 Press **Zero**. During zeroing, which takes approximately 10 seconds, the wait symbol is displayed.
- 3 The setting of the reference calibration factor is obtained from the sensor calibration table and displayed under the **Ref CF** softkey.
- 4 Connect the power sensor to the POWER REF output.

## 2 Power Meter Operation

- 5 Press **Cal** to calibrate the power meter. During calibration, the wait symbol is displayed. (The power meter automatically turns on the POWER REF output.)
- 6 Press . The current setting of the frequency is displayed under the **Freq** softkey.
- 7 To change this setting, press **Freq**. The power meter displays the frequency in a pop-up window. Modify this frequency (see below) as desired.
  - Use  or  to modify the digit on which the cursor is currently positioned.
  - Use  or  to move to other digits.
- 8 To confirm your choice, press the appropriate frequency unit.
- 9 Connect the power sensor to the signal to be measured.
- 10 The measurement result is now displayed.

### NOTE

If the measurement frequency does not correspond directly to a frequency in the sensor calibration table, the power meter calculates the calibration factor using linear interpolation.

If you enter a frequency outside the frequency range defined in the sensor calibration table, the power meter uses the highest or lowest frequency point in the sensor calibration table to set the calibration factor.

The value of the calibration factor being used by the power meter to make a measurement is displayed under the **Cal Fac** softkey.

## Editing Sensor Calibration Tables

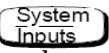
You can edit sensor calibration tables using the “Edit Cal” menu as shown in [Figure 2-5](#). To view the sensor calibration tables currently stored in the power meter, press , **Tables**, **Sensor Cal Tables**. The “Sensor Tbls” screen is displayed as shown in [Figure 2-4](#).

LCL		Edit Cal
Name: <b>HP8481A</b>		Change
Ref CF: 100.0%		
Freq	Cal Fac	Insert
50.00MHz	100.0%	
100.00MHz	99.8%	
2.00GHz	99.0%	
3.00GHz	98.6%	
4.00GHz	98.0%	
5.00GHz	97.7%	
6.00GHz	97.4%	Delete
7.00GHz	97.1%	
		Done
		1 of 1

**Figure 2-5** “Edit Cal Screen”

The power meter is shipped with a set of predefined sensor calibration tables. The data in these tables is based on statistical averages for a range of Agilent Technologies power sensors.

These power sensors are:

- DEFAULT<sup>1</sup>
- HP 8481A
- HP 8482A<sup>2</sup>
- HP 8483A
- HP 8481D
- HP 8485A
- HP R8486A
- HP Q8486A
- HP R8486D
- HP 8487A

There are also ten sensor calibration tables named CUSTOM\_0 through CUSTOM\_9 which do not contain any data when the power meter is shipped from the factory.

<sup>1</sup> DEFAULT is a sensor calibration table in which the reference calibration factor and calibration factors are 100%. This sensor calibration table can be used during the performance testing of the power meter.







<sup>2</sup> The Agilent 8482B and Agilent 8482H power sensors use the same data as the Agilent 8482A.

### NOTE

Predefined sensor calibration factor table stored in power meter is not applicable for Agilent N8480 Series power sensors with Option CFT. Therefore, users are required to create a new sensor calibration table for the sensors when a sensor calibration table is needed.

You cannot delete any of the 20 sensor calibration tables. Each sensor calibration table can contain a maximum of 80 frequency points each. If you want a new sensor calibration table, you must edit an existing one.





To edit a table:

- 1 Select one using the  and  keys to scroll through the displayed tables. When the table you want to edit is highlighted, press **Edit Table**. The “Edit Cal” screen is displayed as shown in [Figure 2-5](#) on [page 47](#). In this screen, you can modify, add, and remove frequency and calibration factors and also edit the table name. Use the , , , and  keys to move between the table name and its frequency and calibration factors.





A frequency in the range of 0.001 MHz to 999.999 GHz can be entered.

A calibration factor in the range of 1% to 150% can be entered.

The following rules apply to naming sensor calibration tables:

- The name must consist of no more than 12 characters.
  - All characters must be upper or lower case alphabetic characters or numeric (0-9) or an underscore (\_).
  - No other characters are allowed.
  - No spaces are allowed in the name.
- 2 To edit the parameter you currently have selected, press **Change**. The power meter displays the data in a pop-up window. Modify this data (see below) as desired.
    - Use  or  to modify the character on which the cursor is currently positioned.
    - Use  or  to move to other characters.
  - 3 To confirm your choice, press the appropriate softkey.
  - 4 To add a new sensor calibration table entry, press **Insert**. You are prompted for the frequency and calibration factor. The entry is sorted by frequency.



- 5 To remove a sensor calibration table entry, use the , , , and  keys to select the entry, press **Delete**. If you delete the frequency, the equivalent calibration factor is also removed and vice versa.

**NOTE**

You can only edit the table name, you cannot delete it.

---

- 6 When you have completed editing the sensor calibration table, press **Done** to return to the “Sensor Tables” screen.

**NOTE**

Ensure that the frequency points you use cover the frequency range of the signals you want to measure. If you measure a signal with a frequency outside the frequency range defined in the sensor calibration table, the power meter uses the highest or lowest frequency point in the sensor calibration table to calculate the calibration factor.

---

## 2 Power Meter Operation

The following lists detail the contents of the predefined sensor calibration tables.

DEFAULT		Agilent 8483A	
RCF	100	RCF	94.6
0.1 MHz	100	0.1 MHz	94
110 GHz	100	0.3 MHz	97.9
<b>Agilent 8481A</b>		1 MHz	98.4
RCF	100	3 MHz	98.4
50 MHz	100	10 MHz	99.3
100 MHz	99.8	30 MHz	98.7
2 GHz	99	100 MHz	97.8
3 GHz	98.6	300 MHz	97.5
4 GHz	98	1 GHz	97.2
5 GHz	97.7	2 GHz	96.4
6 GHz	97.4	3 GHz	93
7 GHz	97.1	4 GHz	91
8 GHz	96.6	<b>Agilent 8481D</b>	
9 GHz	96.2	RCF	99
10 GHz	95.4	50 MHz	99
11 GHz	94.9	500 MHz	99.5
12.4 GHz	94.3	1 GHz	99.4
13 GHz	94.3	2 GHz	99.5
14 GHz	93.2	3 GHz	98.6
15 GHz	93	4 GHz	98.6
16 GHz	93	5 GHz	98.5
17 GHz	92.7	6 GHz	98.5
18 GHz	91.8	7 GHz	98.6
<b>Agilent 8482A</b>		8 GHz	98.7
RCF	98	9 GHz	99.5
0.1 MHz	98	10 GHz	98.6
0.3 MHz	99.5	11 GHz	98.7
1 MHz	99.3	12 GHz	99
3 MHz	98.5	12.4 GHz	99.1
10 MHz	98.5	13 GHz	98.9
30 MHz	98.1	14 GHz	99.4
100 MHz	97.6	15 GHz	98.9
300 MHz	97.5	16 GHz	99.1
1 GHz	97	17 GHz	98.4
2 GHz	95	18 GHz	100.1
3 GHz	93		
4.2 GHz	91		

<b>Agilent R8486A</b>		<b>Agilent 8485A continued</b>	
RCF	100	17 GHz	96.7
50 MHz	100	18 GHz	96.6
26.5 GHz	94.9	19 GHz	96
27 GHz	94.9	20 GHz	96.1
28 GHz	95.4	21 GHz	96.2
29 GHz	94.3	22 GHz	95.3
30 GHz	94.1	23 GHz	94.9
31 GHz	93.5	24 GHz	94.3
32 GHz	93.7	25 GHz	92.4
33 GHz	93.7	26 GHz	92.2
34 GHz	94.9	26.5 GHz	92.1
34.5 GHz	94.5	<b>Agilent R8486D</b>	
35 GHz	94.4	RCF	97.6
36 GHz	93.7	50 MHz	97.6
37 GHz	94.9	26.5 GHz	97.1
38 GHz	93.5	27 GHz	95.3
39 GHz	93.9	28 GHz	94.2
40 GHz	92.3	29 GHz	94.5
<b>Agilent 8485A</b>		30 GHz	96.6
RCF	100	31 GHz	97.6
50 MHz	100	32 GHz	98
2 GHz	99.5	33 GHz	98.9
4 GHz	98.9	34 GHz	99.5
6 GHz	98.5	34.5 GHz	99
8 GHz	98.3	35 GHz	97.6
10 GHz	98.1	36 GHz	99
11 GHz	97.8	37 GHz	98.2
12 GHz	97.6	38 GHz	97.4
12.4 GHz	97.6	39 GHz	97.6
14 GHz	97.4	40 GHz	100
16 GHz	97		

## 2 Power Meter Operation

<b>Agilent 8487A</b>		<b>Agilent 8487A continued</b>	
RCF	100	34.5 GHz	93.5
50 MHz	100	35 GHz	93.1
100 MHz	99.9	36 GHz	92
500 MHz	98.6	37 GHz	92.4
1 GHz	99.8	38 GHz	90.9
2 GHz	99.5	39 GHz	91.3
3 GHz	98.9	40 GHz	91.4
4 GHz	98.8	41 GHz	90.6
5 GHz	98.6	42 GHz	89.9
6 GHz	98.5	43 GHz	89.1
7 GHz	98.4	44 GHz	88.1
8 GHz	98.3	45 GHz	86.9
9 GHz	98.3	46 GHz	85.8
10 GHz	98.3	47 GHz	85.4
11 GHz	98.1	48 GHz	83.2
12 GHz	97.9	49 GHz	81.6
13 GHz	98	50 GHz	80.2
14 GHz	98.2	<b>Agilent Q8486A</b>	
15 GHz	97.7	RCF	100
16 GHz	96.8	50 MHz	100
17 GHz	97	33.5 GHz	91.3
18 GHz	96.3	34.5 GHz	92
19 GHz	95.9	35 GHz	91.7
20 GHz	95.2	36 GHz	91.5
21 GHz	95.6	37 GHz	92.1
22 GHz	95.5	38 GHz	91.7
23 GHz	95.4	39 GHz	91
24 GHz	95	40 GHz	90.7
25 GHz	95.4	41 GHz	90.3
<b>Agilent 8487A</b>		42 GHz	89.5
26 GHz	95.2	43 GHz	88.5
27 GHz	95.1	44 GHz	88.7
28 GHz	95	<b>Agilent Q8486A</b>	
29 GHz	94.4	45 GHz	88.2
30 GHz	94	46 GHz	87
31 GHz	93.7	47 GHz	86.4
32 GHz	93.8	48 GHz	85.3
33 GHz	93	49 GHz	84.7
34 GHz	93.2	50 GHz	82.9

## Making Measurements using Frequency Dependent Offset Tables

This section describes how to use frequency dependent offset tables.

Frequency dependent offset tables provide you with a quick and convenient method of compensating for your external test setup over a range of frequencies. Note that when selected, frequency dependent offset correction is IN ADDITION to any correction applied for sensor frequency response.

The power meter is capable of storing 10 frequency dependent offset tables of 80 frequency points each.

To use frequency dependent offset tables you:

- 1 Select the table to work on a channel. Refer to [“Selecting a Frequency Dependent Offset Table”](#) on page 54 for further information. If you are required to edit the table, refer to [“Editing Frequency Dependent Offset Tables”](#) on page 56 for further information.
- 2 Zero and calibrate the power meter. The reference calibration factor used during the calibration is automatically set by the power meter from the sensor calibration table (if selected).
- 3 Specify the frequency of the signal you want to measure. The calibration factor or offset is automatically set by the power meter from the sensor calibration table (if selected) and the frequency dependent offset table. Refer to [“Making the Measurement”](#) on page 45 for further information.
- 4 Make the measurement.

## Selecting a Frequency Dependent Offset Table

You can select a frequency dependent offset table for use by pressing **System Inputs**, **Tables**, **Freq Dep Offset**, **Table Off On**. The “State” field indicates if any frequency dependent offset tables are currently selected. The “Offset Tbls” screen is displayed as shown in [Figure 2-6](#).

RMT TLK		Offset Tbls	
Tbl	Name	State	Pts
A	CUSTOM_A	off	5
B	CUSTOM_B	off	0
C	CUSTOM_C	off	0
D	CUSTOM_D	off	0
E	CUSTOM_E	off	0
F	CUSTOM_F	off	0
G	CUSTOM_G	off	0
H	CUSTOM_H	off	0
I	CUSTOM_I	off	0
J	CUSTOM_J	off	0

Edit  
Table

Table  
**Off** On





Done

**1 of 1**

Figure 2-6 “Offset Tbls” Screen

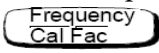
## Making the Measurement

To make the power measurement, you zero and calibrate the power meter, then set it for the frequency of the signal you want to measure. The power meter automatically selects the calibration factor from the sensor calibration table (if selected) and the offset from the frequency dependent offset table.

- 1 Press  .
- 2 Press **Zero**. During zeroing, which takes approximately 10 seconds, the wait symbol is displayed.
- 3 The setting of the reference calibration factor is obtained from the sensor calibration table (if selected) and displayed under the **Ref CF** softkey.
- 4 Connect the power sensor to the POWER REF output.
- 5 Press **Cal** to calibrate the power meter. During calibration, the wait symbol is displayed. (The power meter automatically turns on the POWER REF output.)
- 6 Press  . The current setting of the frequency is displayed under the **Freq** softkey.
- 7 To change this setting, press **Freq**. The power meter displays the frequency in a pop-up window. Modify this frequency (see below) as desired.
  - Use  or  to modify the digit on which the cursor is currently positioned.
  - Use  or  to move to other digits.
- 8 To confirm your choice, press the appropriate frequency unit.
- 9 Connect the power sensor to the signal to be measured.
- 10 The measurement result is now displayed.

**NOTE**

If the measurement frequency does not correspond directly to a frequency in the sensor calibration table (if selected) and the frequency dependent offset table being used, the power meter calculates the calibration factor and offset using linear interpolation.

If you enter a frequency outside the frequency range defined in the sensor calibration table or the frequency dependent offset table, the power meter uses the highest or lowest frequency point in the appropriate table to set the calibration factor and offset.

The value of the calibration factor being used by the power meter to make a measurement is displayed under the **Cal Fac** softkey.

## Editing Frequency Dependent Offset Tables

You can edit frequency dependent offset tables using the “Edit” menu as shown in [Figure 2-7](#).

To view the frequency dependent offset tables currently stored in the power meter, press **System Inputs**, **Tables**, **Freq Dep Offset**. The “Offset Tbls” screen is displayed as shown in [Figure 2-6](#).

RMT TLK		Edit Offset
Name: <b>CUSTOM_A</b>		Change
<b>Freq</b>	<b>Offset</b>	Insert
5.000MHz	90.0%	Delete
6.000MHz	80.0%	Done
7.000MHz	70.0%	
8.000MHz	60.0%	
9.000MHz	50.0%	
		1 of 1







**Figure 2-7** “Edit” Screen



There are ten frequency dependent offset tables named CUSTOM\_A through CUSTOM\_J which do not contain any data when the power meter is shipped from the factory.

You cannot delete any of the 10 existing frequency dependent offset tables or create any additional tables. However, you can edit the 10 existing tables. Each frequency dependent offset table can contain a maximum of 80 frequency points.









To edit a table:

- 1 Select one using the  or  keys to scroll through the displayed tables. When the table you want to edit is highlighted, press **Edit Table**. The “Edit Offset” screen is displayed as shown in [Figure 2-7](#) on [page 56](#). In this screen, you can modify, add, and remove frequencies and offset and also edit the table name. Use the , , , and  keys to move between the table name and its frequencies and offsets.

A frequency in the range of 0.001 MHz to 999.999 GHz can be entered.

An offset in the range of 1% to 150% can be entered.

- The following rules apply to naming frequency dependent offset tables:
- The name must consist of no more than 12 characters.
- All characters must be upper or lower case alphabetic characters or numeric (0-9) or an underscore (\_).
- No other characters are allowed.
- No spaces are allowed in the name.

- 2 To edit the parameter you currently have selected, press **Change**. The power meter displays the data in a pop-up window. Modify this data (see below) as desired.
  - Use  or  to modify the character on which the cursor is currently positioned.
  - Use  or  to move to other characters.
- 3 To confirm your choice, press the appropriate softkey.
- 4 To add a new frequency dependent offset table entry, press **Insert**. You are prompted for the frequency and offset. The entry is sorted by frequency.
- 5 To remove a frequency dependent offset table entry, use the , , , and  keys to select the entry, press **Delete**. If you delete the frequency, the equivalent offset is also removed and vice versa.

## 2 Power Meter Operation

### NOTE

You can only edit the table name, you cannot delete it.

---

- 6 When you have completed editing the frequency dependent offset table, press **Done** to return to the “Offset Tbls” screen.

### NOTE

Ensure that the frequency points you use cover the frequency range of the signals you want to measure. If you measure a signal with a frequency outside the frequency range defined in the frequency dependent offset table, the power meter uses the highest or lowest frequency point in the frequency dependent offset table to calculate the offset.

---

## Setting the Units of Measurement

The “dBm/W” menu is used to select the measurement units on the currently selected window. These can either be logarithmic (dBm or dB) or linear (Watt or %) units.  sets the measurement units to dBm (logarithmic units). [Table 2-5](#) shows which units are applicable to the individual measurement modes.

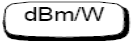
Press , then select the unit of measurement from **dBm**, **W**, **dB**, or **%**. Softkeys which cannot be selected in your particular mode of operation appear with their text grayed out.

### NOTE

When the unit of measurement is set to Watt, it is possible that negative power measurements may be displayed when measuring low power levels.

**Table 2-5** Measurement Units

Measurement Mode	Relative Mode Off		Relative Mode On <sup>1</sup>	
	Linear	Log	Linear	Log
Single Channel	Watt	dBm	%	dB

<sup>1</sup> When relative mode is on (that is, , **Rel Off On** is “On”), the measurement is compared to a reference value.

## Selecting Units of Measurement from the Softkeys

In various softkey menu structures, you are required to enter the units of measurement for power. In some cases, due to the wide power range available, the following menu is displayed:

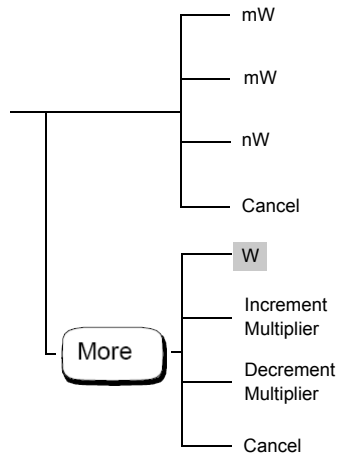

### NOTE

Some softkeys may be grayed out so that an invalid value cannot be entered.

Pressing **Increment Multiplier** or **Decrement Multiplier** increases or decreases the multiplier shown in front of **W**. Pressing **W** after the correct multiplier has been selected confirms the entry.

## Making Relative Measurements

Relative mode allows you to compare any measurement result to a reference value. The relative reading can be displayed in either dB or % by pressing **dBm/W** and selecting either **dB** or **%**. When the measurement result is displayed in %, a prefix multiplier may be shown.

Relative mode is window dependent and when enabled, displays “Rel” in the window to which it’s applied.

### Procedure

To set a reference value on the currently selected window:

- 1 Press **Rel Offset**.
- 2 Press **Rel** to use the current reading as the reference value. This allows you to compare any measurement result in dB or percentage (%).
- 3 **Rel Off On** is automatically set to “On”, when **Rel** is pressed.

Successive measurements are now displayed relative to the reference value. The relative mode can be disabled and re-enabled simply by pressing **Rel Off On**.

### Setting the Resolution

The resolution of each of the power meter's windows can be set to four different levels (1, 2, 3, or 4).

These four levels represent:

- 1, 0.1, 0.01, 0.001 dB respectively if the measurement suffix is dBm or dB.
- 1, 2, 3, or 4 significant digits respectively if the measurement suffix is W or %.

The default value is 0.01 dB (3 digits).

To set the resolution on the currently selected window:

- 1 Press **Meas Setup**. The current setting of the resolution is highlighted on the **Resolution 1 2 3** softkey.
- 2 To change this setting, press **Resolution 1 2 3** until the required resolution setting is highlighted.

## Setting Offsets





### Setting Channel Offsets

The power meter can be configured to compensate for a signal loss or gain in your test setup (for example, to compensate for the loss of a 10 dB attenuator). This gain or loss, referred to as a channel offset, is added to the measured power before the result is displayed.

Offsets are entered in dB. The allowable range of values is -100 dB to +100 dB. A positive value compensates for a loss and a negative value compensates for a gain.

If either a channel or a display offset is set, then “Ofs” is displayed.

To enter a channel offset which compensates for a loss or gain:

- 1 Press .
- 2 Press **Input Settings**.
- 3 Press **Offset**. The power meter displays the offset value in a pop-up window. Modify this offset (see below) as desired.
  - Use  or  to modify the digit on which the cursor is currently positioned.
  - Use  or  to move to other digits.
- 4 To confirm your choice, press **dB**.
- 5 **Offset Off On** is automatically set to “On” when a value is entered using **Offset**.





Channel offsets can be disabled and re-enabled simply by pressing **Offset Off On**.

## Setting Display Offsets

The display offset function provides a method for entering display offset values.

If either a channel or a display offset is set, then “Ofs” is displayed.

To enter a display offset on the currently selected window:

- 1 Press , **Offset**.
- 2 The power meter displays the offset value in a pop-up window. Modify this offset (see below) as desired.
  - Use  or  to modify the digit on which the cursor is currently positioned.
  - Use  or  to move to other digits.
- 3 To confirm your choice, press **dB**.
- 4 **Offset Off On** is automatically set to “On”, when a value is entered using **Offset**.

Display offsets can be disabled and re-enabled simply by pressing **Offset Off On**.

The display offset is a function of the window. That is, if you have selected a two window display, each can have its own offset.

Figure 2-8 displays the effects of the channel and display offsets on the power meter’s displayed reading.

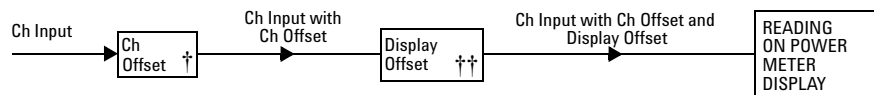

**Figure 2-8** Effect of Offsets on a Channel Measurement

† Channel Offset entered using , **Input Settings**, **Offset**.

†† Display Offset entered using , **Offset**.



## Setting Averaging

The power meter uses a digital filter to average power readings. The number of readings averaged can range from 1 to 1024. This filter is used to reduce noise, obtain the desired resolution and to reduce the jitter in the measurement results. Increasing the value of the filter length reduces measurement noise. However, the time to take the measurement is increased. You can select the filter length or you can set the power meter to auto filter mode. The default is “AUTO”.

When the auto filter mode is enabled, the power meter automatically sets the number of readings averaged together to satisfy the filtering requirements for most power measurements. The number of readings averaged together depends on the resolution and the power level currently being measured. [Figure 2-9](#) lists the number of readings averaged for each range and resolution when the power meter is in auto filter mode and is set to normal speed mode (refer to the *Agilent EPM- 4418B/4419B Programming Guide* for details of the readings averaged in the other speed modes).

Resolution is a window function and not a channel function. In the case, where a channel is set up in both the upper and lower window and the resolution settings are different, the highest resolution setting is taken to calculate the averaging number. For example, if the upper window has a resolution setting of two and is measuring channel A and the lower window has a resolution of four and is also measuring channel A. In this instance, channel A averaging is calculated with a resolution of four.

## 2 Power Meter Operation

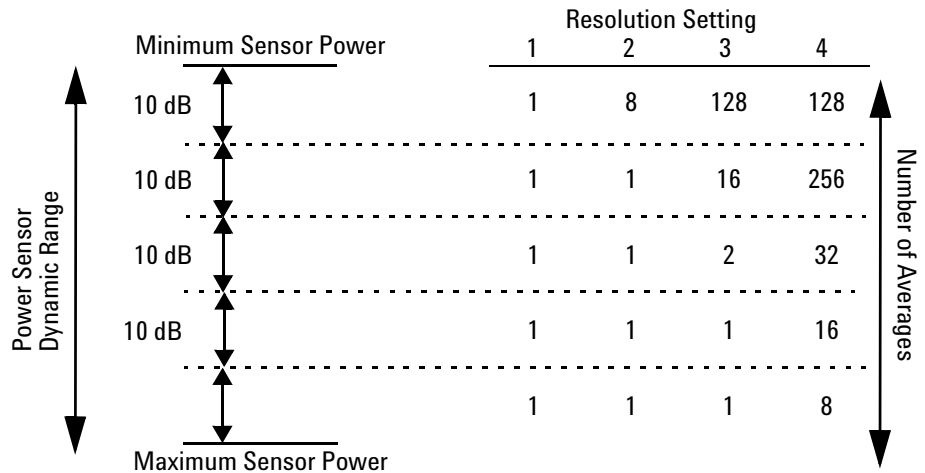

**Figure 2-9** Averaged Readings

These four resolution levels represent:

- 1, 0.1, 0.01, 0.001 dB respectively if the measurement suffix is dBm or dB.
- 1, 2, 3, or 4 significant digits respectively if the measurement suffix is W or %.

To set averaging:

- 1 Press **System Inputs**, **Input Settings**, **More**. Press the **Filter** softkey to access the filter menu.
- 2 The current setting of averaging is displayed under the **Length** softkey. To change this setting, press **Length**. A pop-up window appears. Use the **Up**, **Down**, **Left**, or **Right** keys to set your filter length.
- 3 To confirm your choice, press **Enter**.

The filter can be disabled and re-enabled simply by pressing **Filter Off On**.

## Step Detection

To reduce the filter settling time after a significant step in the measured power, the filter can be set to re-initialise upon detection of a step increase or decrease in the measured power. Step detection can be set in both manual and automatic filter modes.

To set step detection:

- 1 Press **System Inputs**, **Input Settings**, **More**.
- 2 Press the **Filter** softkey to access the filter menu.
- 3 Use the **Step Det Off On** softkey to enable or disable step detection.

## Measuring Pulsed Signals

The power meter can be used to measure the power of a pulsed signal. The measurement result is a mathematical representation of the pulse power rather than an actual measurement (assumes constant peak power). The power meter measures the average power of the pulsed input signal and then divides the measurement result by the duty cycle value to obtain the pulse power reading. The allowable range of values is 0.001% to 100%. The default value is 1.000%.

If duty cycle is enabled, then “Dty Cyc” is displayed.

**NOTE**





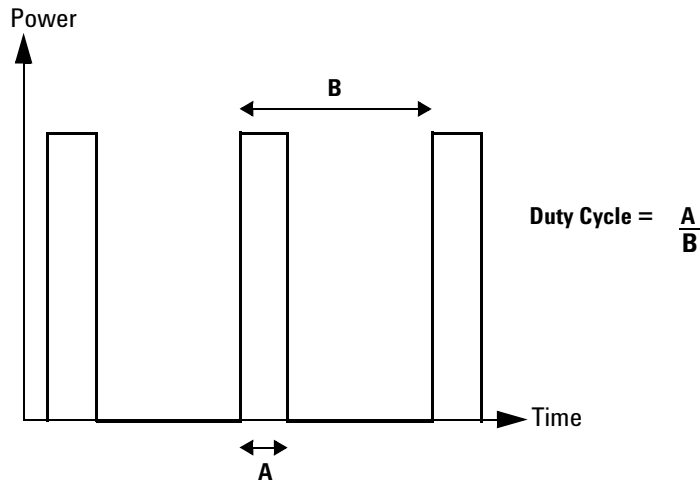

Pulse measurements are not recommended using Agilent E4412A and E4413A power sensors.

An example of a pulsed signal is shown in [Figure 2-10](#).



**Figure 2-10** Pulsed Signal

To set the duty cycle:

- 1 Press , **Input Settings**, . The current setting of the duty cycle is displayed under the **Duty Cycle** softkey.
- 2 To change this setting, press **Duty Cycle**. The power meter displays the duty cycle in a pop-up window. Modify this value (see below) until the desired duty cycle is displayed.
  - Use  or  to modify the digit on which the cursor is currently positioned.
  - Use  or  to move to other digits.
- 3 To confirm your choice, press **%**.
- 4 **Duty Cycle Off On** is automatically set to “On”, when a value is entered using **Duty Cycle**.

Duty cycle can be disabled and re-enabled simply by pressing **Duty Cycle Off On**.

## NOTE

Pulse power averages out any aberrations in the pulse such as overshooting or ringing. For this reason, it is called pulse power and not peak power or peak pulse power.

In order to ensure accurate pulse power readings, the input signal must be pulsed with a rectangular pulse. Other pulse shapes (such as triangle, chirp, or Gaussian) will cause erroneous results.

The pulse power on or off ratio must be much greater than the duty cycle ratio.

# Setting Measurement Limits

You can configure the power meter to detect when a measurement is outwith a predefined upper and/or lower limit value.

There are two types of measurement limits you can set:

- Channel Limits - are applied to the input channel and are for power measurements only.
- Window Limits - are windows based (upper and lower) and can be applied to power, ratio, or difference measurements. In addition, the window based limits can be set to output a TTL logic level at the rear panel Rmt I/O port when the predefined limits are exceeded.





### NOTE

Only one set of limits can be on at a time, that is, Channel, OR Window.

## Setting Channel Limits

The power meter can be configured to verify the power being measured against an upper and/or lower limit value. The range of values that can be set for upper and lower limits is  $-150$  dBm to  $230$  dBm. The default upper limit is  $90.00$  dBm and the default lower limit is  $-90.00$  dBm.

To set the limits:

- 1 Press , **Input Settings**, **Limits**. The current setting of the maximum and minimum limits are displayed under the **Max** and **Min** softkeys respectively.
- 2 To change either of these settings, press the appropriate softkey. The power meter displays the current value in a pop-up window. Modify this value (see below) until the desired value is displayed.
  - Use  or  to modify the digit on which the cursor is currently positioned.
  - Use  or  to move to other digits.
- 3 To confirm your choice, press the appropriate measurement units.

Limits can be disabled and re-enabled simply by pressing **Limits Off On**.

A typical application for this feature is shown in [Figure 2-11](#).

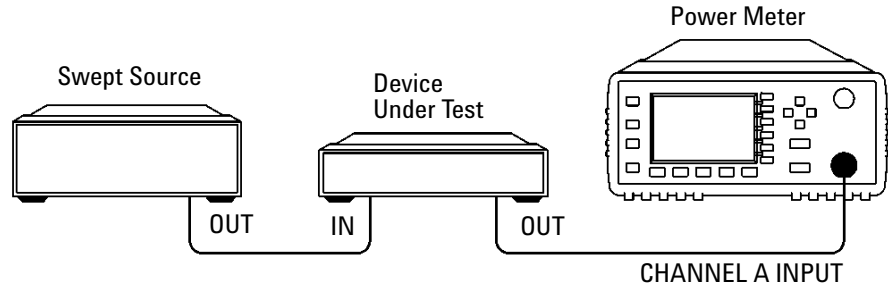

**Figure 2-11** Limits Checking Application

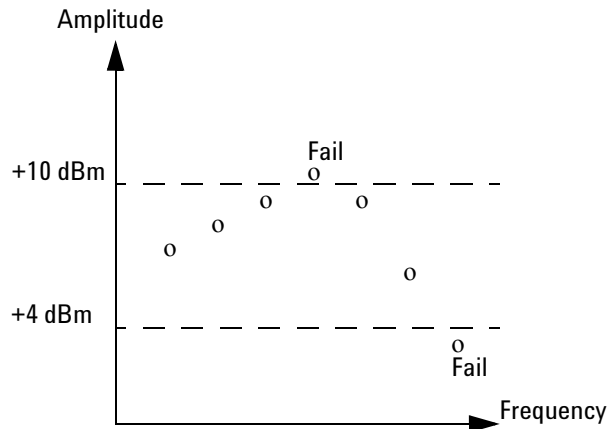

**Figure 2-12** Limits Checking Results

In this application, a swept frequency signal is applied to the input of the Device Under Test. The power meter measures the output power. The limits have been set at +4 dBm and +10 dBm. A fail occurs each time the output power is outside these limits as shown in [Figure 2-12](#).

## Setting Window Limits

The power meter can be configured to verify the current measurement in either window against predefined upper and/or lower limit values. The range of values that can be set for the upper and lower limits and the default values depends on the measurement units in the currently selected window, see [Table 2-6](#).

**Table 2-6** Range of Values for Window Limits

Window Units	Max	Min	Default MaxMin	
dB	+200 dB	-180 dB	60 dB	-120 dB
dBm	+230 dBm	-150 dBm	90 dBm	-90 dBm
%	10.0 Z%	100.0 a%	100.0 M%	100.0 p%
W	100.000 XW	1.000 aW	1.000 MW	1.000 pW

The window based limits can also be set to output a TTL logic level at the rear panel Rmt I/O port when the predefined limits are exceeded. You can switch the rear panel TTL outputs, on, or off; set the TTL output level to active high or low; and determine whether the TTL output represents an over limit condition, under limit condition or both.

The TTL connector is an RJ-45 Series shielded modular jack assembly with the TTL output pins connected as shown in [Figure 2-13](#).





To set the TTL output:

- 1 Press **Meas Setup**, **Limits**, **TTL Output** . The current settings for the TTL output are displayed under the **TTL Output**, **Limits**, and **Fail O/P** softkeys.
- 2 To select whether the TTL output reflects an overlimit condition, under limit condition or both, press **Limits** . Use any of the four arrow keys to make a selection between **OVER**, **UNDER**, and **EITHER** on the pop-up menu that appears.
- 3 To select whether a high or low level TTL output represents a limits failure, use the **Fail O/P** softkey to toggle between **High** and **Low**

TTL outputs can be disabled and re-enabled simply by pressing **TTL Output Off On**.

### Checking for Limit Failures

Limit failures are displayed in the appropriate field in the measurement window on the power meter's display as shown in [Figure 2-14](#).

#### NOTE

The same limit fail field is used by both channel and window limits.

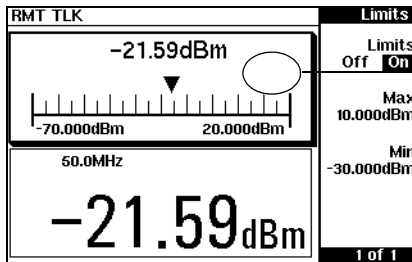

This measurement has passed. This is indicated by the limit field being empty.

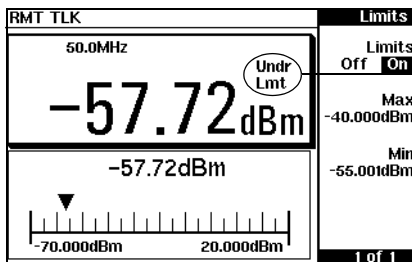

This measurement has failed as the result is less than the minimum limit level set of -55 dBm. This is indicated with the text “Undr Lmt”.

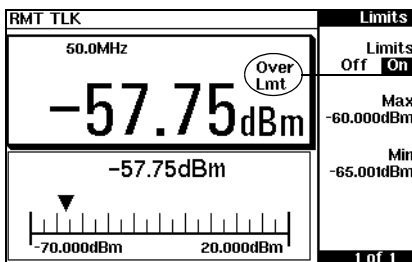

This measurement has failed as the result is more than the maximum limit level set of -60 dBm. This is indicated with the text “Over Lmt”.

Figure 2-14 Pass/Fail Limit Indicators

## Selecting a Digital or Analog Display

The measurement windows can display the result in either a digital or analog format or both as shown in the following figures.

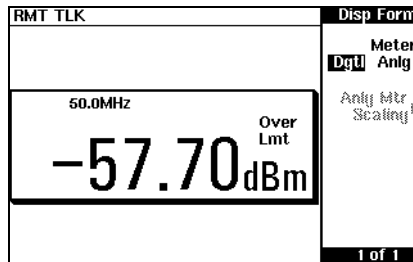

Figure 2-15 Digital Display

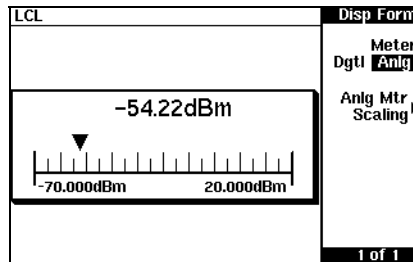

Figure 2-16 Analog Display

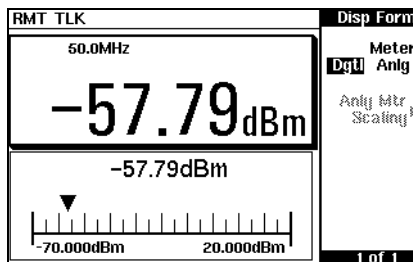





Figure 2-17 Digital and Analog Display

To select the format of the display in the currently selected window:

- 1 Press **Meas Setup**, **Display Format**.
- 2 Press **Meter Dgtl Anlg** to highlight the type of format you require. Pressing this key toggles between a digital and analog display.

To select the range of the analog display in the currently selected window:

- 1 Press **Meas Setup**, **Display Format**, **Anlg Mtr Scaling**.
- 2 The current setting of the maximum and minimum values displayed on the analog meter are displayed under the **Max** and **Min** softkeys respectively.
- 3 To change either of these settings, press the appropriate softkey. The power meter displays the current value in a pop-up window. Modify this value (see below) until the desired value is displayed.
  - Use  or  to modify the digit on which the cursor is currently positioned.
  - Use  or  to move to other digits.
- 4 The choices available depend on the unit of measurement selected and the current measurement mode. If the measurement unit selected is logarithmic, then the choice will be **dB** or **dBm**. If the measurement unit selected is linear, then choose the appropriate softkeys from the following menus:

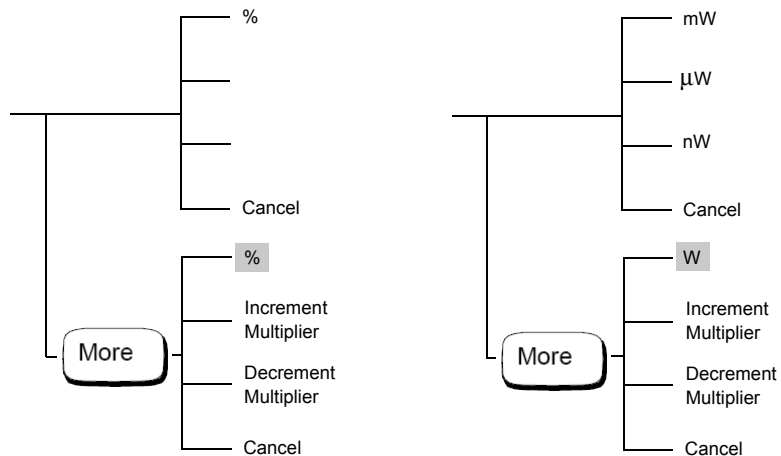

## 2 Power Meter Operation

Pressing **Increment Multiplier** or **Decrement Multiplier** increases or decreases the multiplier shown in front of **%** or **W**. Pressing **%** or **W** after the correct multiplier has been selected confirms the entry.

To select both an analog and digital display, press  until the two windows are displayed. Select the format of one window to analog and the other to digital as previously described.

To indicate if the measurement reading is outwith the minimum or maximum values set for the analog meter, a warning message is displayed. The analog meter also displays a digital reading. This digital reading allows you to easily set the appropriate minimum and maximum values for the analog display.

### NOTE



The analog display does not indicate as much measurement data as the digital display. That is, it does not indicate when duty cycle, range hold, offset, or relative mode are enabled. In addition, it does not indicate if the measurement is within the test limits if any are set.

---

## Setting the Range

The power meter has no internal ranges which can be set. The only ranges that can be set are those of the Agilent E-Series power sensors and N8480 Series power sensors (excluding Option CFT) . With an Agilent E-Series power sensor or N8480 Series power sensor (excluding Option CFT), the range can be set either automatically or manually. Use autoranging when you are not sure of the power level you will be measuring. There are two manual settings either “LOWER” or “UPPER”. The lower range is more sensitive than the higher range. “LOWER” covers the range of -70 dBm to -13.5 dBm. “UPPER” covers the range of -14.5 dBm to +20 dBm. The default is “AUTO”.

To set the range:

- 1 Press , **Input Settings** . The current setting of the range is displayed under the **Range** softkey.
- 2 To change this setting, press **Range**. A pop-up window appears. Use  or  to highlight your choice.
- 3 To confirm your choice, press **Enter**.

## Configuring the Remote Interface

This section explains how to configure the power meter for remote control using either the GPIB parallel interface or the RS232/422 serial interface. For further information on using the power meter remotely, refer to the *Agilent EPM- 4418B/4419B Programming Guide*.

### GPIB

To select GPIB as the remote interface, press , **Remote Interface**, **Select Interface**, **GPIB** (IEEE 488).





#### GPIB Address

Each device on the GPIB (IEEE-488) interface must have a unique address. You can set the power meter's address to any value between 0 and 30. The address is set to 13 when the power meter is shipped from the factory.

The address is stored in nonvolatile memory and does not change when the power is switched off or after a remote interface reset.

Your GPIB bus controller has its own address. Avoid using the bus controller's address for any instrument on the interface bus.

To set the GPIB address from the front panel:

- 1 Press , **Remote Interface**, **Configure Interface**, **GPIB**. The current setting of the GPIB address is displayed under the **GPIB Addr** softkey.
- 2 To change this setting, press **GPIB Addr**. The power meter displays the address in a pop-up window. Modify this address (see below) as desired.
  - Use  or  to modify the digit on which the cursor is currently positioned.
  - Use  or  to move to other digits.
- 3 To confirm your choice, press **Enter**.

To set the GPIB address from the remote interface, use the `SYSTem:COMMunicate:GPIB:ADDRess` command.



## RS232/RS422

With RS232 selected as the serial interface, the power meter communicates through the serial port with single ended drivers and receivers. With RS422 selected, the serial port uses balanced drivers and receivers.

The power meter acts as a DTE device.

To select RS232 or RS422 as the remote interface, press **System Inputs**, **Remote Interface**, **Select Interface**, **RS232**, or **RS422**.

### RS232/422 Connector

The serial port connector is a 9 pin male D-type wired as shown in [Figure 2-18](#).

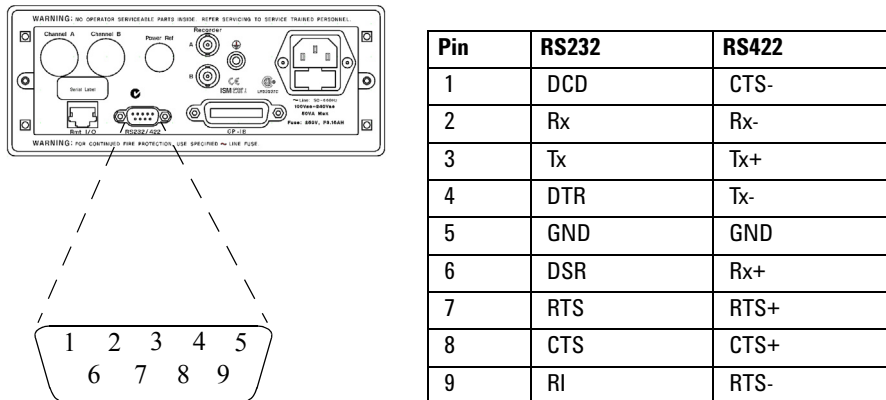

**Figure 2-18** RS232/ 422 Pin Assignment

### Setting the RS232/422 Parameters

This section explains how to set the baud rate, word size, parity, number of stop bits, pacing, and echo for the serial interface.

To set the serial interface parameters:

- 1 Press **System Inputs**, **Remote Interface**, **Configure Interface**, **Serial**. The current settings for **Baud rate**, **Word size**, **Stop bits**, and **Parity** are shown under the softkeys.
- 2 To change the baud rate, press **Baud rate**. The power meter displays the baud rate in a pop-up window. Change the setting by using the **Up** and **Down** keys to run through the selection of baud rates available. To confirm your choice, press **Enter**.
- 3 To change the word size, press **Word size**. The power meter displays the word size in a pop-up window. Change the setting by using any of the arrow keys to toggle between a word size of seven or eight. To confirm your choice, press **Enter**.
- 4 To change the number of stop bits, press **Stop bits**. The power meter displays the number of stop bits in a pop-up window. Change the setting by using any of the arrow keys to toggle between a setting of one or two. To confirm your choice, press **Enter**.
- 5 To change the parity type, press **Parity**. The power meter displays the parity type in a pop-up window. Change the setting by using any of the arrow keys to select from EVEN, ODD, ZERO, ONE, or NONE. To confirm your choice, press **Enter**.
- 6 Press **More** to access page 2 of 2. This page allows you to set echo off and on and gives access to the pacing menu.
- 7 Press **Echo** to toggle between off and on. When echo is on, all received characters will be transmitted (echoed) back to the sender.
- 8 Press **Pacing** to access the pacing menu which allows you to enable or disable various software and hardware pacing options. Pacing will prevent receiver overrun errors and is generally only required when large amounts of data are being transferred (for example, cal tables).
- 9 Press **Tx Pacing** to toggle between enabling and disabling the Xon/Xoff transmitter software handshake. When enabled “Xon” is highlighted, otherwise “None” is highlighted.
- 10 Press **Rx Pacing** to toggle between enabling and disabling the Xon/Xoff receiver software handshake. When enabled “Xon” is highlighted, otherwise “None” is highlighted.
- 11 Press **RTS/CTS** and use any of the arrow keys to select one of the following from the pop-up menu:  
OFF - Sets the RTS signal line permanently low.

ON - Sets the RTS signal line permanently high.

IBFull - Sets the RTS signal line high while the receiver buffer can accept more data and sets RTS low when the data buffer is full. The transmitter is inhibited when CTS is low.

**12** Press **DTR/DSR** and use any of the arrow keys to select one of the following from the pop-up menu:

OFF - Sets the DTR signal line permanently low.

ON - Sets the DTR signal line permanently high.

IBFull - Sets the DTR signal line high while the receiver buffer can accept more data and sets DTR low when the data buffer is full. The transmitter is inhibited when DSR is low.

The **DTR/DSR** softkey is greyed out if the RS422 interface is selected.

## Remote Interface Overview

You can view a summary of your remote interface settings at any time by pressing **System Inputs**, **Remote Interface**, **Interface Overview**. Examples of an GPIB and RS422 interface overview are shown in [Figure 2-19](#).

## 2 Power Meter Operation

RMT TLK	Overview
<b>REMOTE INTERFACE OVERVIEW</b>	
Interface : GPIB Command Set : SCPI GPIB Address : 13	
	Done
	1 of 1

LCL	Overview
<b>REMOTE INTERFACE OVERVIEW</b>	
Interface : RS422 Command Set : SCPI Baud Rate : 9600 bits/second Word Length : 8 bits Stop Bits : 1 Parity : None Echo : Off Rx Pacing : None      RTS/CTS : Off Tx Pacing : None      DTR/DSR : Off	
	Done
	1 of 1

**Figure 2-19** Interface Overview Examples

Pressing the **Done** softkey returns the power meter display to the previous screen.

## Programming Language Selection

You can select one of the two languages to program the power meter from the remote interface. The language is SCPI when the power meter is shipped from the factory. The other language is the Agilent 437B programming language.

The power meter complies with the rules and regulations of the 1995.0 version of SCPI (Standard Commands for Programmable Instruments). You can determine the SCPI version with which the power meter is in compliance by sending the `SYSTem:VERSion?` command from the remote interface. You cannot query the SCPI version from the front panel.

The language selection is stored in nonvolatile memory and does not change when power has been off or after a remote interface reset.

To select the interface language from the front panel:

- 1 Press , **Remote Interface**, **Command Set**.
- 2 Select the language you require from **HP 437B** and **SCPI**.

To select the interface language from the remote interface, use the `SYSTem:LANGUage` command

## Recorder Output

The rear panel Recorder Output connector produces a DC voltage that corresponds to the power level in Watts of the channel, depending on the measurement mode. This DC voltage ranges from 0 to +1 Vdc. The output impedance is typically 1 kW. Channel and display offsets and duty cycle have no effect on the Recorder Output.

For example, the Recorder Output can be used to;

- record swept measurements on an X-Y recorder
- level an output from a source using external leveling or
- monitor the output power on a strip chart recorder. A setup for recording swept measurements is shown in [Figure 2-20](#).

See [Figure 2-22](#) for details on which power meter functions are implemented in the recorder output.

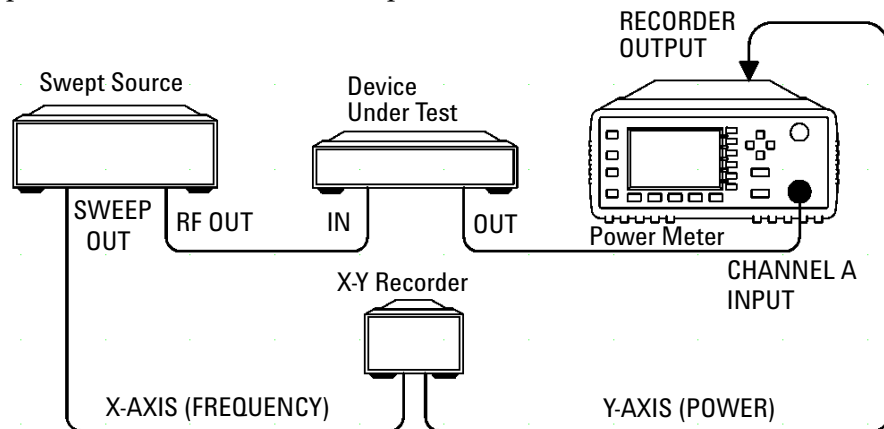

**Figure 2-20** Test Setup for Recording Swept Measurements

To access the “Recorder” menu, press **System Inputs**, **More**, **Recorder Output**. This menu allows you to switch the Recorder Output signal either on or off. The **Max Power** and **Min Power** softkeys allow you to enter the input power level that you want to represent the 1 Vdc maximum and 0 Vdc minimum output voltage of the Recorder Output.

## Leveling a Source Output

The Recorder output can be used to level an output from a source using external leveling. The following procedure explains how to do this:

- 1 Select the Recorder Output by pressing **System Inputs**, **More**, **Recorder Output**.
- 2 The highest power you are going to measure is used to determine the value which you should set for the Recorder Output maximum setting. For example, if you are measuring a power less than 1 mW and greater than 100  $\mu$ W, then set the recorder maximum value to 1 mW.

50 dBm (100 W)
40 dBm (10 W)
30 dBm (1 W)
20 dBm (100 mW)
10 dBm (10 mW)
0 dBm (1 mW)
-10 dBm (100 $\mu$ W)
-20 dBm (10 $\mu$ W)
-30 dBm (1 $\mu$ W)
-40 dBm (100 nW)
-50 dBm (10 nW)
-60 dBm (1 nW)



- 3 To set the maximum value, press **Max Power** and enter the appropriate value.
- 4 Press **Min Power** and enter 0 W.
- 5 Press **Output Off On** to “On”.

## Saving and Recalling Power Meter Configurations







To reduce repeated setup sequences, up to ten power meter configurations can be stored in the power meter's nonvolatile memory. The GPIB address and command set, the data stored in the sensor calibration tables and the zeroing and calibration data are not stored by a preset. The calibration table selected is not affected.

Power meter configurations are saved and recalled with the  key.



To save the current measurement setup:

- 1 Press .
- 2 Use the  and  keys to scroll through the displayed files. When the required file is highlighted, press **Save**.
- 3 Press **Confirm**.

If you require to modify the name of a file:

- 1 Press .
- 2 Use the  and  keys to scroll through the displayed files. When the required file is highlighted, press **Edit Name**. The power meter displays the file name in a pop-up window. Modify this name (see below) until the desired name is displayed.
  - Use  or  to modify the character on which the cursor is currently positioned.
  - Use  or  to move to other characters.
  - Use **Insert Char** and **Delete Char** as required.
- 3 To confirm your choice, press **Enter**.

To recall a measurement setup:

- 1 Press .
- 2 Use the  and  keys to scroll through the displayed files. When the required file is highlighted, press **Recall**.
- 3 Press **Confirm**.



LCL			Save/Recall
Reg	Name	Status	
0	<b>State0</b>	Available	Save
1	State1	Available	
2	State2	Available	Recall
3	State3	Available	
4	State4	Available	Edit
5	State5	Available	Name
6	State6	Available	
7	State7	Available	Done
8	State8	Available	
9	State9	Available	
			1 of 1

Figure 2-21 "Save/Recall" Screen

## How Measurements are Calculated

Figure 2-22 details how measurements are calculated. It shows the position in which the various power meter functions are implemented in the measurement calculation.

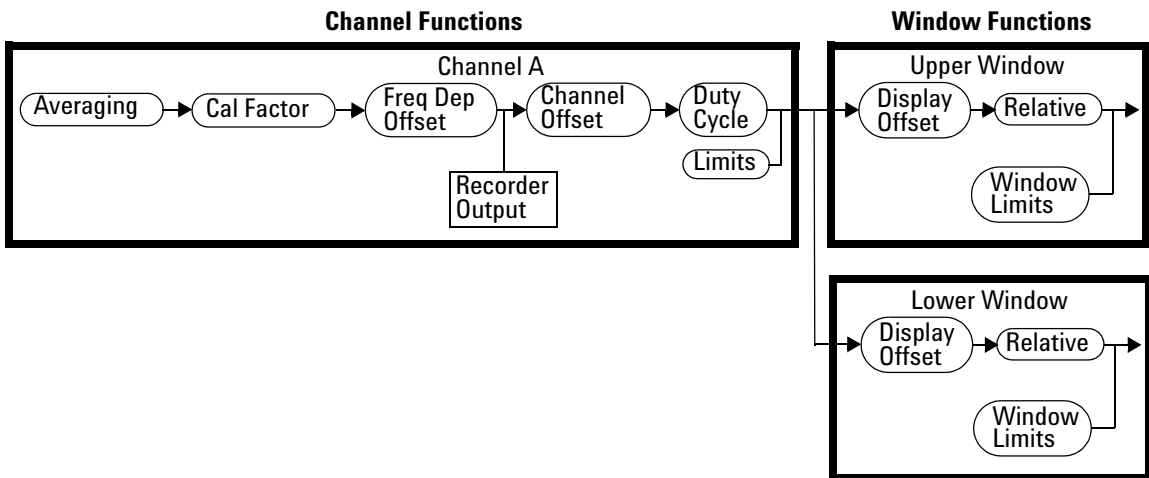

Figure 2-22 How Measurements are Calculated

## Presetting the Power Meter

This section details the power meter's preset conditions.

The GPIB address and command set, the data stored in the sensor calibration tables and the zeroing and calibration data are not affected by a preset. The calibration table selected is not affected.

### Preset Conditions

The number of windows displayed is two.

dBm/W

Measurement units used is set to dBm.

Frequency  
Cal Fac

- **Freq** is set to 50 MHz.
- **Cal Fac** is set to 100%.

Meas  
Setup

- **Display Format** is set to digital in the upper window and analog in the lower window.
- **Anlg Mtr Scaling** is set to 20.000 dBm (**Max**) and -70.000 dBm (**Min**).
- **Resolution 1 2 3 4** is set to "3".
- **Limits Off/On** is set to "Off"
- **Limits** is set to 90.000 dBm (**Max**) and -90.000 dBm (**Min**).
- **TTL Output Off/On** is set to "Off".
- **Limits OVER, UNDER, EITHER** is set to "OVER".
- **Fail O/P High/Low** is set to "Low"

## 2 Power Meter Operation

### Rel Offset

- Rel Off/On is set to “Off”.
- Offset Off/On is set to “Off”.
- Offset is set to 0.000 dB.

### System Inputs

- Command Set is not affected.
- Select Interface is not affected.
- GPIB Addr is not affected.
- Baud Rate is not affected.
- Word Size is not affected.
- Stop Bits is not affected.
- Parity is not affected.
- Pacing is not affected.
- Echo is not affected.
- Table Off/On is not affected.
- Filter Off/On is set to “On”.
- Filter is set to “AUTO”.
- Duty Cycle Off/On is set to “Off”.
- Duty Cycle is set to 1.000%.
- Offset Off/On is set to “Off”.
- Offset is set to 0.000 dB.
- Range is set to “AUTO”.
- Limits is set to 90.000 dbm (Max) and -90.000 dBm (Min).
- Limits Off/On is set to “Off”.
- Power Ref Off/On is set to “Off”.
- Recorder Output is set to 100.0 mW (Max Power) and 0.00 W (Min Power).
- Output Off/On is set to “Off”.
- Must Cal Off/On is not affected.

- Backlight Off/On is set to “On”



- Ref CF is set to 100%.
- Must Cal Off/On is not affected.
- TTL Inputs Off/On is set to “Off”.

# Self Test

The power meter has three distinct self test modes:



- power on self test, which occurs automatically when you turn on the power meter.
- confidence check, which is accessed via the front panel and requires your assistance in order to verify the POWER REF and measurement path accuracy.
- troubleshooting mode, which is accessed via the front panel or remotely. The front panel softkey menu allows you to run individual tests, whereas the remote command runs a complete series of tests as listed in “[Remote Testing](#)” on page 97.

## Power On Self Test

The power on self test is performed automatically when the power meter is turned on and takes approximately 10 seconds to complete. The power on self test consists of the following tests:

- RAM Battery
- Calibrator
- Measurement AssemblyFan
- Serial Interface
- Option 001 Battery

Refer to “[Test Descriptions](#)” on page 98, if you require a description of each individual test.

As the power on self test takes place, the message “Testing...” appears next to the name of the test which is being performed. When each test is complete, the message “Testing...” is replaced by either the message “Passed” or “Failed”. The Option 001 Battery test can also produce the message “Not Present”. If a failure occurs, the message “Power-up H/W Err” appears. Any errors are also written to the error queue and can be examined in the “Errors” screen by pressing , , [Error List](#).

## Front Panel Selection of Self Tests

Press **System Inputs**, **More**, **Service**, **Self Test** to access a test menu which consists of the following tests:

- Instrument Self Test
- Confidence Check
- Individual, which accesses a menu which consists of the following tests:
  - Memory
  - RAM Battery
  - Measurement Assembly
  - Calibrator
  - Keyboard
  - Fan
- Display, which accesses a menu which consists of the following tests:
  - Display Assembly
  - Display RAM
  - Bitmap Displays
- Serial Interface, which accesses a menu which consists of the following tests:
  - UART Configuration
  - Local Loop Back
  - RS232 Loop Back
  - RS422 Loop Back

### NOTE

The RS232 and RS422 loop back tests require a specially wired connector - refer to the *Agilent E4418B/E4419B Service Guide*.

Each of these tests can be run individually. Information on the instrument self test and confidence check are described on [page 96](#). Refer to “[Test Descriptions](#)” on [page 98](#), if you require a description of the other tests.

When an individual test is selected, the message “Testing...” appears next to the name of the test. When the test is complete, the message “Testing...” is replaced by either the message “Passed” or “Failed”. This pass/fail indication excludes the keyboard test and the bitmap display test, both of which rely on your interaction to detect a failure.

When the individual test is complete, the result is displayed until **Done** is selected. If the self test failed, information about the failure is displayed on the screen.

### Instrument Self Test

If **Instrument Self Test** is selected, the following tests are run, these are the same tests which are run using the \*TST? command.

- ROM checksum
- RAM
- RAM Battery
- Display Assembly
- Calibrator
- Measurement AssemblyFan
- Serial Interface

As each test takes place, the name of the test is listed on the screen. While a test is running, the message “Testing...” appears next to the name of the test. As each stage of the test is completed, the message “Testing...” is replaced by either the message “Passed” or “Failed”.

### Confidence Check

The confidence check requires you to carry out the following procedure. Instructions are also displayed on the screen.

- 1 Connect the power sensor to the POWER REF output (Refer to [Table 2-1](#) on page 33 for connection requirements for the Agilent 8480 Series power sensors). The power reference signal is turned on automatically after any key is pressed.
- 2 The power meter automatically makes a power measurement. If the measured error is within the instrument accuracy specification, the confidence check has been successful. While the test is running, the message “Testing...” appears. If the correct



power meter reading is made, the message “Passed” is displayed, otherwise “Failed” is displayed.

If the confidence check fails, the failure appears in the error queue. To examine the error queue, go to the “Errors” screen (refer to [Chapter 4](#)).

## Remote Testing

To invoke the remote self test, the IEEE 488.1 compliant standard command, \*TST? is used. This command runs a full self test and returns one of the following codes:

- 0 - no tests failed
- 1 - one or more tests failed

The remote self test consists of the following tests:

- ROM checksum
- RAM
- RAM Battery
- Display Assembly
- Calibrator
- Measurement Assembly
- Communications Assembly (Implicit)

The communications assembly is tested implicitly, in that the command will not be accepted or return a result unless the GPIB interface is functioning correctly.

Refer to [“Test Descriptions”](#) on page 98, if you require a description of each individual test.

When the \*TST? command is executed, the screen is cleared. As each test takes place, the name of the test is listed on the screen. While a test is running, the message “Testing...” appears next to the name of the test. As each stage of the test is completed, the message “Testing...” is replaced by either the message “Passed” or “Failed”.

### Test Descriptions

This section specifies what is actually checked by each of the tests. Some of the tests may only be applicable to one method of invocation (for example, from the front panel). If this is the case, it is specified in the test description. Most of the tests have an associated error message which is added to the error queue if the test fails. The exception to this is the bitmap display test. Refer to [Chapter 4, “Error Messages”](#) for details on these error messages.

#### ROM Checksum

This test calculates the checksum of the firmware and checks it against the pre-defined checksum stored on the ROM. A pass or a fail result is returned.

#### RAM

This test carries out a read and write test on the instrument RAM.

#### RAM Battery

When the firmware is first downloaded, a known value is written into a battery-backed memory location. This test verifies that the value is still resident. It returns a pass if the value is still present, otherwise it returns a fail.

#### Measurement Assembly

A measurement assembly is requested to automatically run a self test. This self test returns either a pass or a fail. A fail can either be produced by the measurement assembly self test failing or by the measurement assembly not responding.

#### Fan

This test confirms that the internal cooling fan is operating.

## Serial Interface

Four tests are available for the serial interface: UART configuration, local loop back, RS232 loop back and RS422 loop back. Both the RS232 and RS422 loop back tests require a specially wired connector - refer to the *Agilent E4418B/E4419B Service Guide*.

- UART Configuration - confirms that the baud rate, stop bits and parity settings are correctly configured on the UART.
- Local Loop Back - Tx and Rx on the UART are internally connected and a test message is sent to confirm correct operation.
- RS232/RS422 Loop Back - A message is sent via the UART and transceivers using an external loop back connector (refer to the *Agilent E4418B/E4419B Service Guide*).

## Option 001 Battery

This test checks that the capacity of the Option 001 battery has not decayed below 70% of its original value. The test is only performed on power meters fitted with Option 001.

## Calibrator

The reference calibrator is turned on (indicated by the POWER REF LED) and measured internally. A pass or fail result is returned.

## Keyboard (Front Panel only)

The power meter enters a mode where you are invited to press any key. When a key is pressed, its name appears on the screen. You can check that the power meter is displaying the expected name when the relevant key is pressed. This is a check that the power meter is receiving the correct keyboard signal. Pressing the same key twice sequentially exits this mode and returns you to a display that lists all the keys that were not entered. If the test is exited without all the keys being pressed, a list is displayed showing all the keys which were not selected.

## Display



Three tests are available for the display: the display assembly, display RAM and bitmap display.

## 2 Power Meter Operation

A read or write is performed on the display RAM. If the value which is written is read back correctly, a pass is recorded, otherwise a fail is recorded.

The liquid crystal display/ light emitting diode (LCD/LED) control circuits are tested by making separate voltage measurements via the multiplexer and digital signal processor. If the expected voltages are measured, a pass is recorded, otherwise a fail is recorded. The three circuits which are tested are the LCD contrast control, the LED brightness control and the display temperature sensing diode.

### **Bitmap Display (Front Panel only)**

A series of bitmaps are displayed on the power meter showing: two checkboards, vertical lines, horizontal lines, oblique lines, all pixels on and all pixels off. Pressing  cycles you through these bitmaps. The  key stops the display and returns you to the previous menu.

## Operator Maintenance

This section describes how to replace the power line fuse and clean the power meter. If you need additional information about replacing parts or repairing the power meter, refer to the *Agilent E4418B/E4419B Service Guide*.

To clean the power meter, disconnect its supply power and wipe with a damp cloth only.

The power line fuse is located within the power meter's fuse holder assembly on the rear panel. For all voltages, the power meter uses a 250 V, F3.15AH, 20 mm fast blow fuse with high breaking capacity (Agilent part number 2110-0957).

### NOTE

The power meter also has an internal fuse. If you suspect that this fuse needs to be replaced, it must be done by trained service personnel. Please refer to [“Returning Your Power Meter for Service”](#) on page 107.

## Replacing the Power Line Fuse

- 1 Remove the power cord from the power meter.
- 2 Slide the fuse holder assembly from the rear panel as shown in [Figure 2-23](#).
- 3 Install the correct fuse in the “In line” position as shown in [Figure 2-23](#). (A spare fuse can be stored in the fuse holder assembly.)
- 4 Replace the fuse holder assembly in the rear panel.

## 2 Power Meter Operation

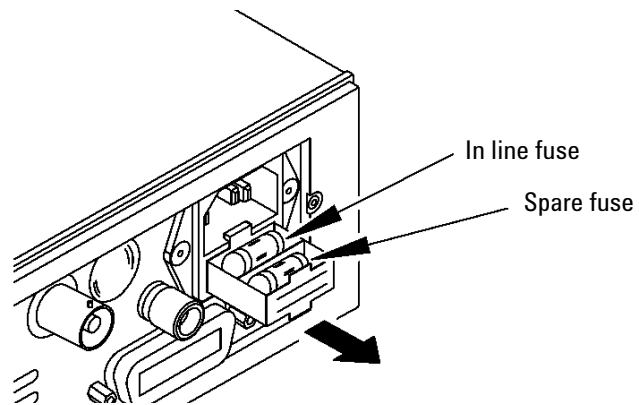

**Figure 2-23** Replacing the fuse

## Contacting Agilent Technologies

This section details what to do if you have a problem with your power meter.

If you have a problem with your power meter, first refer to this section . This chapter contains a checklist that will help identify some of the most common problems.

If you wish to contact Agilent Technologies about any aspect of the power meter, from service problems to ordering information, refer to “[Sales and Service Offices](#)” on page 106.

If you wish to return the power meter to Agilent Technologies refer to “[Returning Your Power Meter for Service](#)” on page 107.

### Before calling Agilent Technologies

Before calling Agilent Technologies or returning the power meter for service, please make the checks listed in “[Check the Basics](#)” on page 104. If you still have a problem, please read the warranty printed at the front of this guide. If your power meter is covered by a separate maintenance agreement, please be familiar with the terms.

Agilent Technologies offers several maintenance plans to service your power meter after warranty expiration. Call your Agilent Technologies Sales and Service Center for full details.

If the power meter becomes faulty and you wish to return the faulty instrument, follow the description on how to return the faulty instrument in the section “[Sales and Service Offices](#)” on page 106.

### Check the Basics

Problems can be solved by repeating what was being performed when the problem occurred. A few minutes spent in performing these simple checks may eliminate time spent waiting for instrument repair. Before calling Agilent Technologies or returning the power meter for service, please make the following checks:

- Check that the line socket has power.
- Check that the power meter is plugged into the proper AC power source.
- Check that the power meter is switched on.
- Check that the line fuse is in working condition.
- Check that the other equipment, cables, and connectors are connected properly and operating correctly.
- Check the equipment settings in the procedure that was being used when the problem occurred.
- Check that the test being performed and the expected results are within the specifications and capabilities of the power meter.
- Check the power meter display for error messages. Refer to [Chapter 4](#) for further information.
- Check operation by performing the self tests.
- Check with a different power sensor.

### Instrument serial numbers

Agilent Technologies makes frequent improvements to its products to enhance their performance, usability, and reliability. Agilent Technologies service personnel have access to complete records of design changes for each instrument, based on the instruments' serial number and option designation.

Whenever you contact Agilent Technologies about your power meter, have a complete serial number available. This will ensure that you obtain the most complete and accurate service information. The serial number can be obtained by:

- interrogating the power meter over the GPIB using the \*IDN? command.



- from the front panel by selecting **System Inputs**, **More**, **Service**, **Version**.
- from the serial number label.

The serial number label is attached to the rear of each Agilent Technologies instrument. This label has two instrument identification entries. The first provides the instruments serial number and the second provides the identification number for each option built into the instrument.

The serial number is divided into two parts: the prefix (two letters and the first four numbers) and the suffix (the last four numbers).

- The prefix letters indicate the country of manufacture. This code is based on the ISO international country code standard and is used to designate the specific country of manufacture for the individual product. The same product number could be manufactured in two different countries. In this case, the individual product serial numbers would reflect different country of manufacture codes. The prefix also consists of four numbers. This is a code identifying the date of the last major design change.
- The suffix indicates an alpha numeric code which is used to ensure unique identification of each product throughout Agilent Technologies.

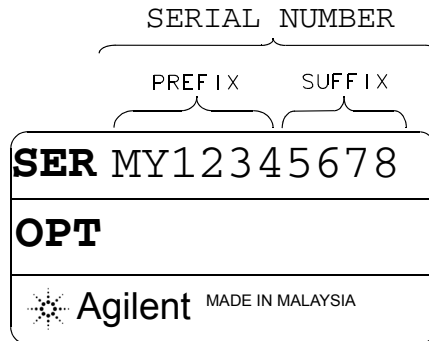

## Sales and Service Offices

For more information about Agilent Technologies test and measurement products, applications, services, and for a current sales office listing, visit our web site:<http://www.agilent.com>

You can also contact one of the following centers and ask for a test and measurement sales representative.

United States:

(tel) 800 829 4444 (fax) 800 829 4433

Canada:

(tel) 877 894 4414 (fax) 800 746 4866

China:

(tel) 800 810 0189 (fax) 800 820 2816

Europe:

(tel) 31 20 547 2111

Japan:

(tel) (81) 426 56 7832 (fax) (81) 426 56 7840

Korea:

(tel) (080) 769 0800 (fax) (080) 769 0900

Latin America:

(tel) (305) 269 7500

Taiwan:

(tel) 0800 047 866 (fax) 0800 286 331

Other Asia Pacific Countries:

(tel) (65) 6375 8100 (fax) (65) 6755 0042

In any correspondence or telephone conversations, refer to the power meter by its model number and full serial number. With this information, the Agilent Technologies representative can quickly determine whether your unit is still within its warranty period.

## Returning Your Power Meter for Service

Use the information in this section if you need to return your power meter to Agilent Technologies.

### Package the Power Meter For Shipment

Use the following steps to package the power meter for shipment to Agilent Technologies for service:

- 1 Fill in a blue service tag (available at the end of this guide) and attach it to the power meter. Please be as specific as possible about the nature of the problem. Send a copy of any or all of the following information:
  - Any error messages that appeared on the power meter display.
  - Any information on the performance of the power meter.

### CAUTION

Power meter damage can result from using packaging materials other than those specified. Never use styrene pellets in any shape as packaging materials. They do not adequately cushion the power meter or prevent it from shifting in the carton. Styrene pellets cause power meter damage by generating static electricity and by lodging in the rear panel.

- 2 Use the original packaging materials or a strong shipping container that is made of double-walled, corrugated cardboard with 159 kg (350 lb) bursting strength. The carton must be both large enough and strong enough to accommodate the power meter and allow at least three to four inches on all sides of the power meter for packing material.
- 3 Surround the power meter with at least three to four inches of packing material or enough to prevent the power meter from moving in the carton. If packing foam is not available, the best alternative is SD-240 Air Cap™ from Sealed Air Corporation (Commerce, CA 90001). Air Cap looks like a plastic sheet covered with 1-1/4 inch air filled bubbles.

## 2 Power Meter Operation

Use the pink Air Cap to reduce static electricity. Wrap the power meter several times in the material to both protect the power meter and prevent it from moving in the carton.

- 4 Seal the shipping container securely with strong nylon adhesive tape.
- 5 Mark the shipping container “FRAGILE, HANDLE WITH CARE” to ensure careful handling.
- 6 Retain copies of all shipping papers.



## 3 Menu Reference

Introduction	110
The Front Panel Menu Maps	111
Front Panel Menu Reference	120



## Introduction







This chapter is a reference to the softkey menu structure of the power meter.

“[The Front Panel Menu Maps](#)” starting on [page 111](#) details the menus diagrammatically.

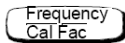
“[Front Panel Menu Reference](#)” starting on [page 120](#) details the menus descriptively.

## The Front Panel Menu Maps

The following diagrams detail the structure of the softkey menus which are accessed through the following seven keys:

- 
- 
- 
- 
- 
- 
- 

### NOTE

On your power meter, some softkey labels have numeric values displayed under them. These values show the current setting of that softkey. Since these values are variable, they are shown in a grayed out text on the following menu maps.

### dBm/W Menu

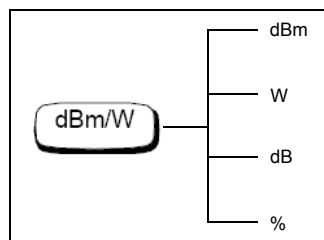

### NOTE

Depending on the power meter's setup, you will be unable to select certain softkeys. The text on these softkey labels appears grayed out. Refer to the appropriate softkey descriptions for further information.

## Frequency/Cal Fac Menu

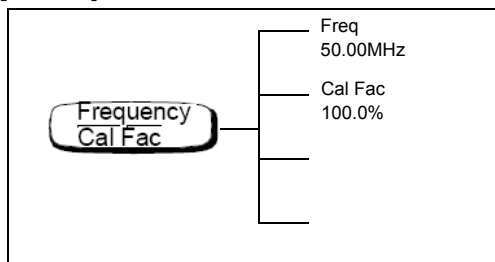

**NOTE**

Depending on the power meter's setup, you will be unable to select certain softkeys. The text on these softkey labels appears grayed out. Refer to the appropriate softkey descriptions for further information.

---



## Meas Setup Menu

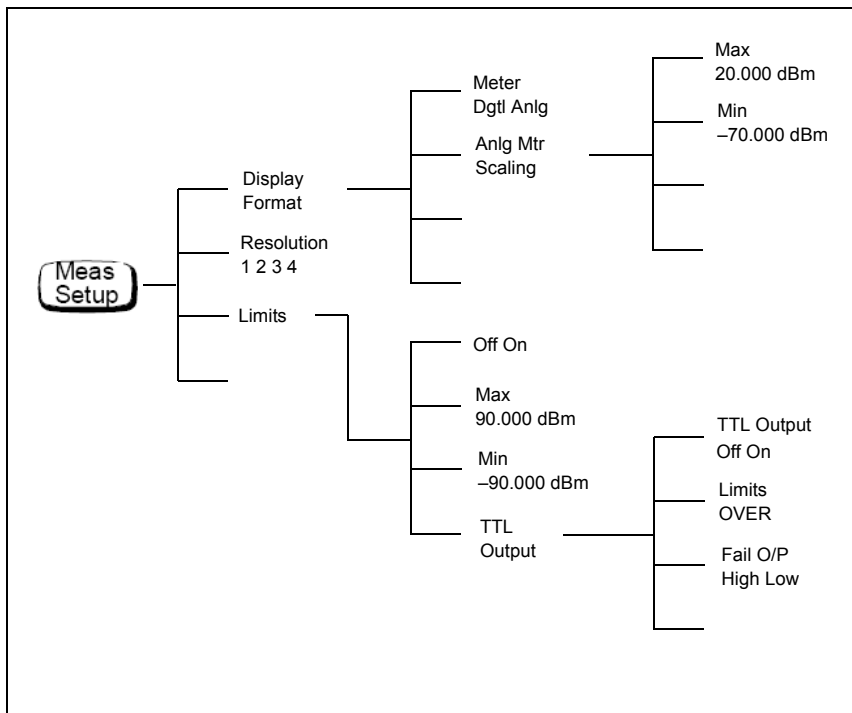

### Rel/Offset Menu

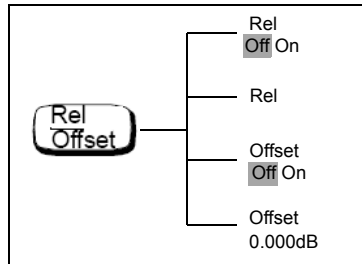

### Save/Recall Menu

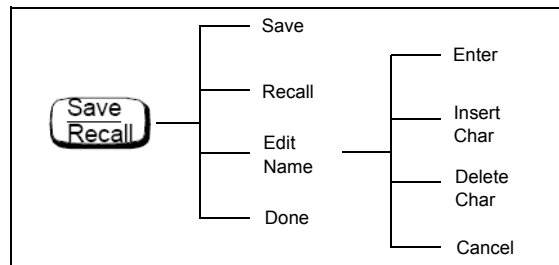

**NOTE**

Depending on the power meter's setup, you will be unable to select certain softkeys. The text on these softkey labels appears grayed out. Refer to the appropriate softkey descriptions for further information.

## System Inputs Menu (1 of 4)

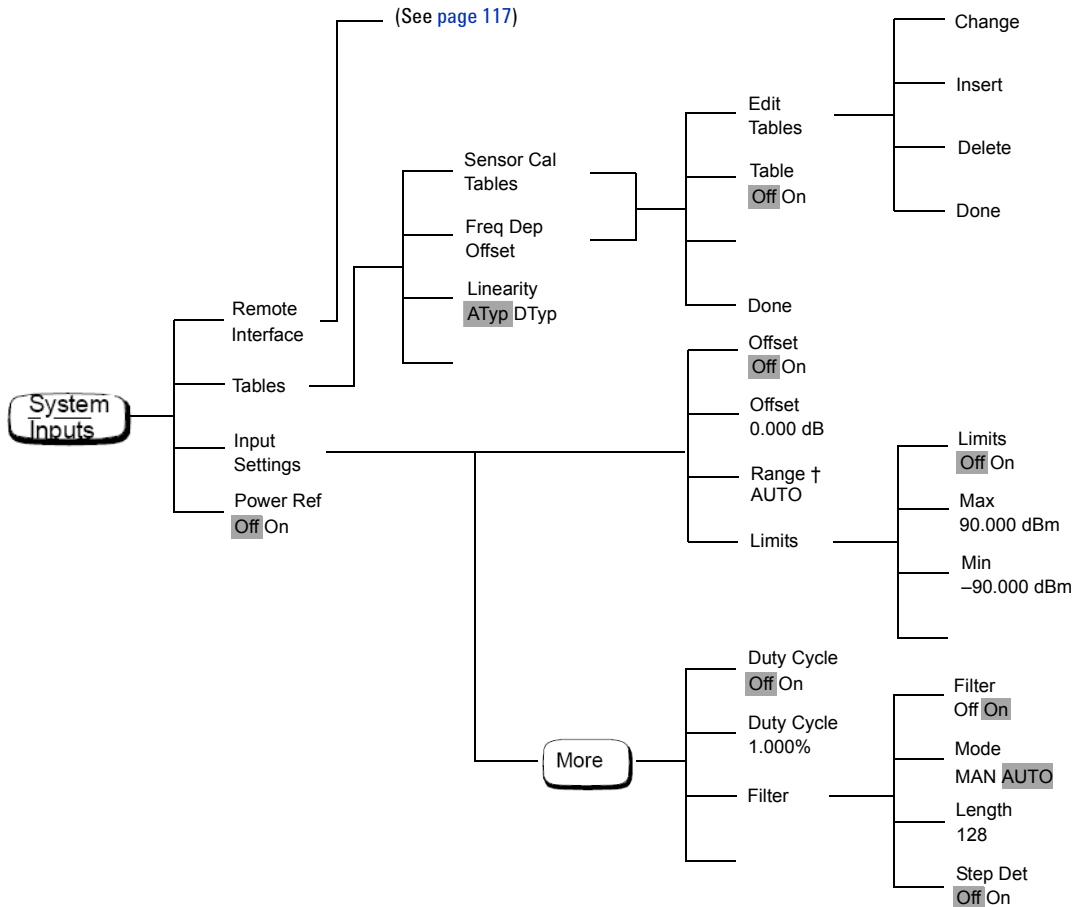

† Agilent E-Series sensors and N8480 Series sensors (excluding Option CFT) only.

### NOTE

Depending on the power meter's setup, you will be unable to select certain softkeys. The text on these softkey labels appears grayed out. Refer to the appropriate softkey descriptions for further information.

## System Inputs Menu (2 of 4)

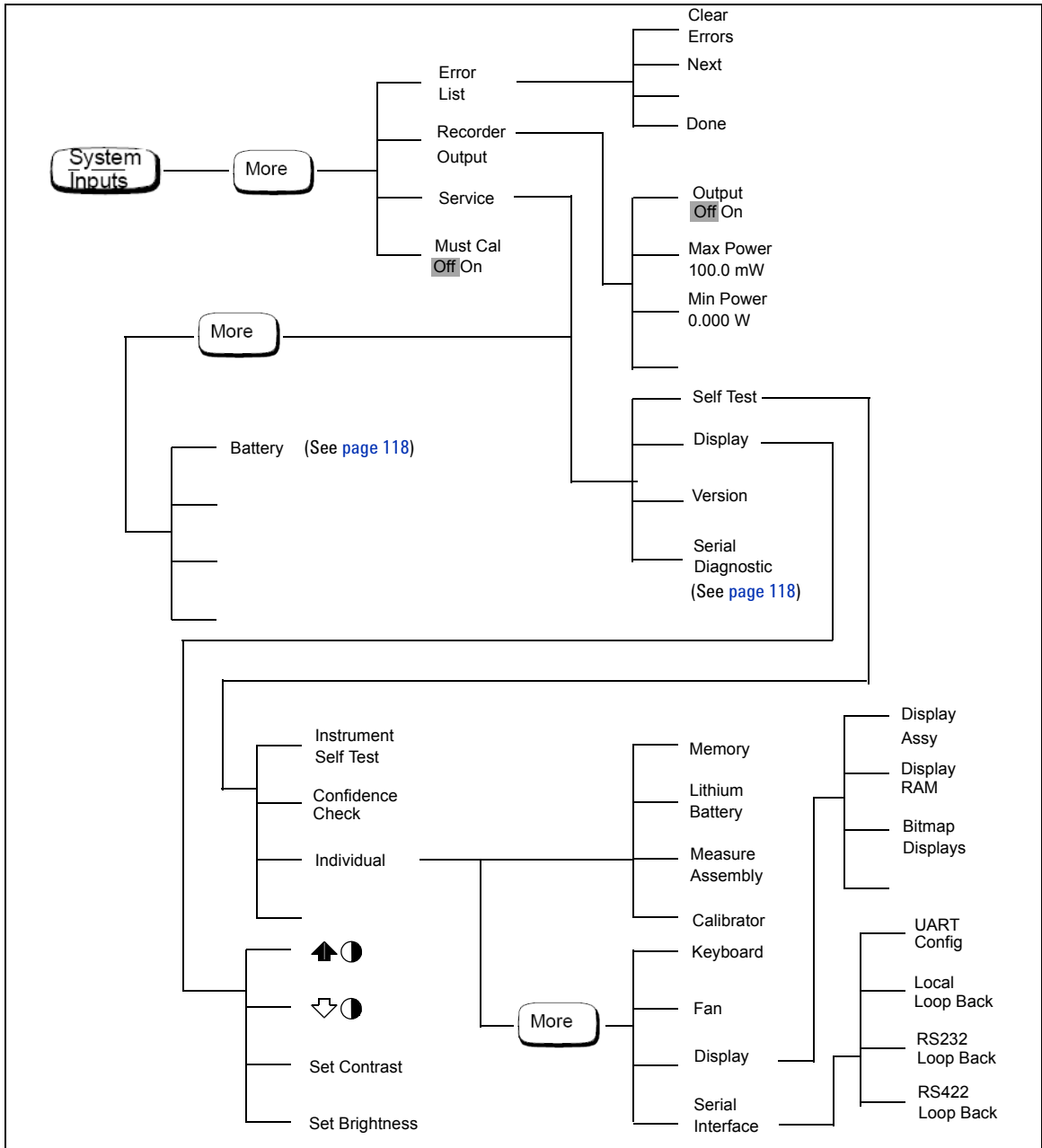

### System Inputs Menu (3 of 4)

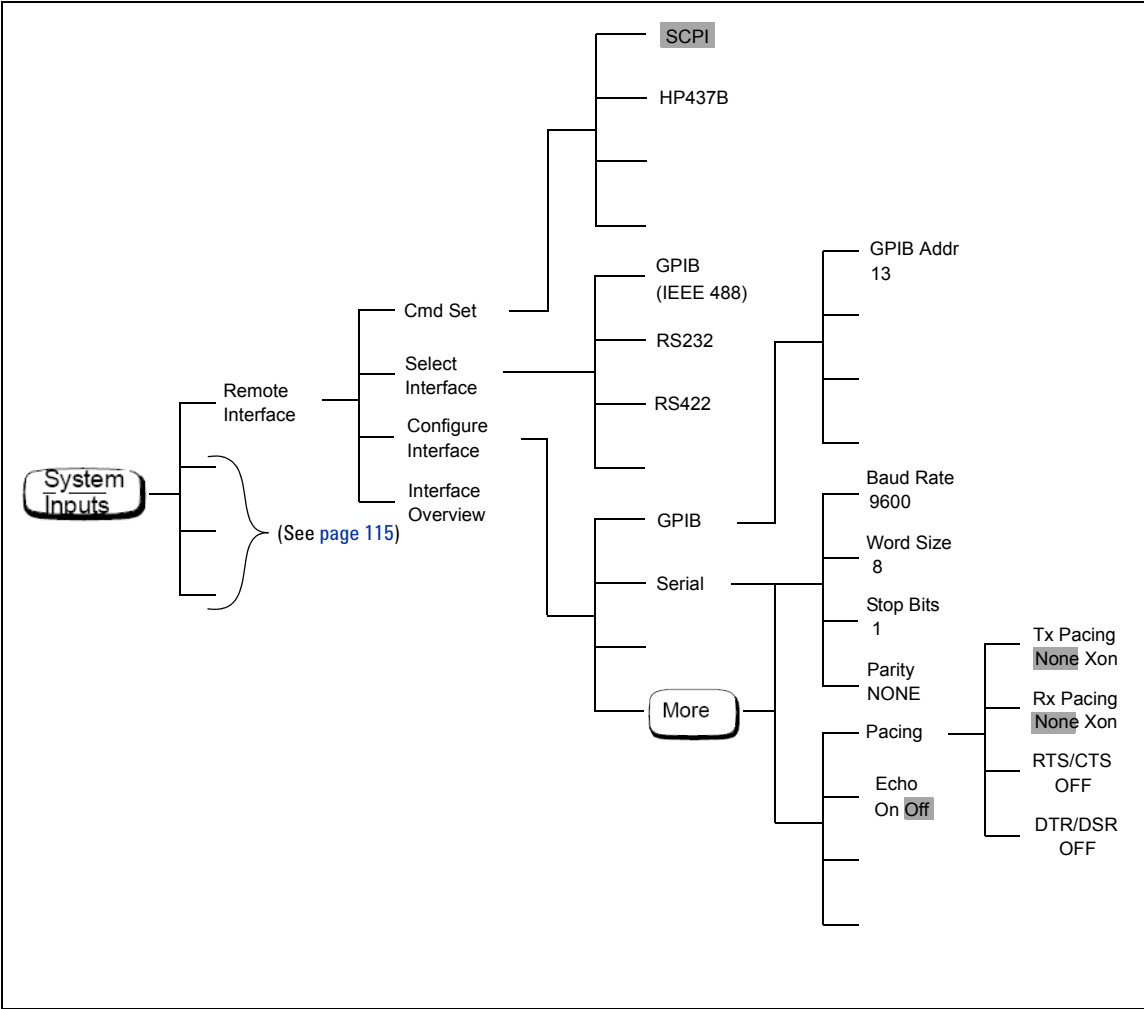

## System Inputs Menu (4 of 4)

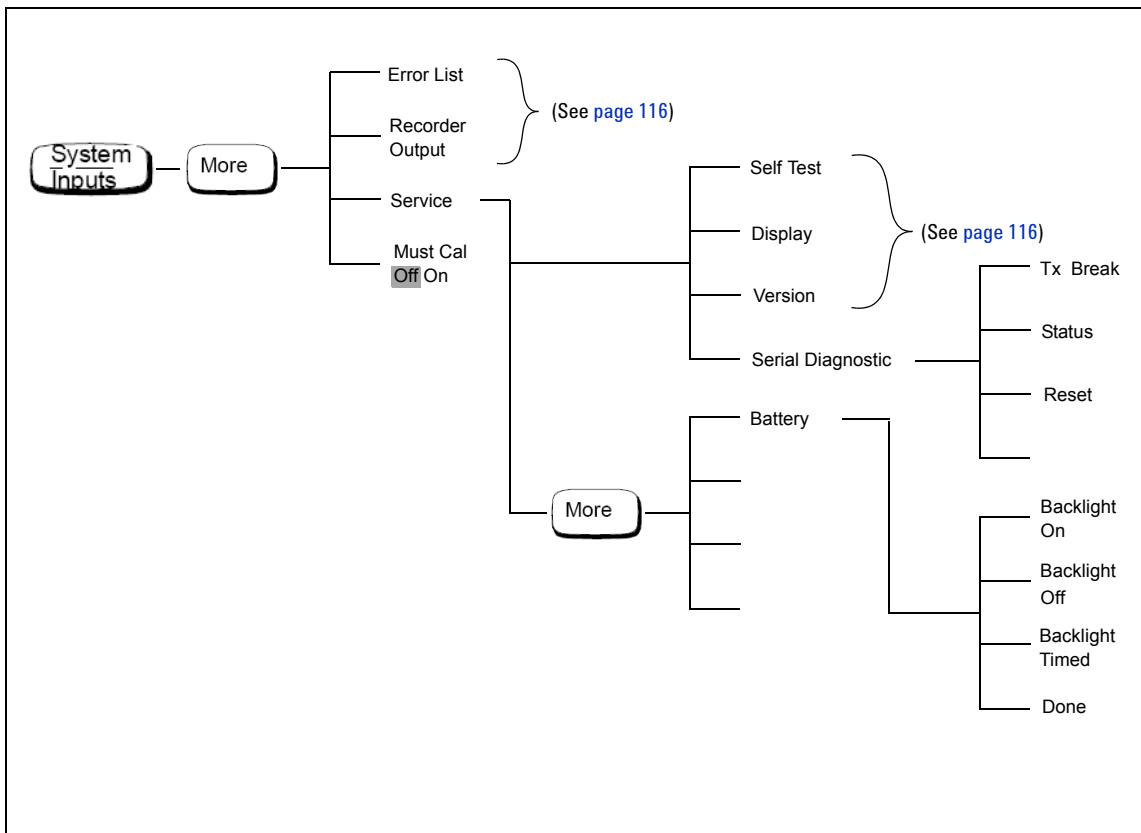

## Zero/Cal Menu

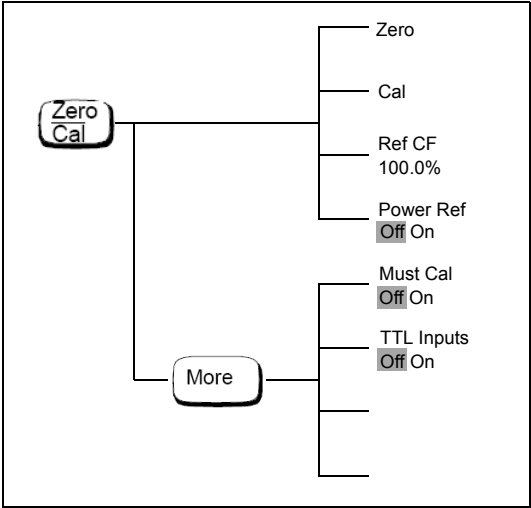

**NOTE**

Depending on the power meter’s setup, you will be unable to select certain softkeys. The text on these softkey labels appears grayed out. Refer to the appropriate softkey descriptions for further information.

## Front Panel Menu Reference

This section describes all the keys and softkeys on your power meter. The key descriptions are in alphabetical order. The softkey descriptions are in the order they appear in the menus. Diagrammatical keys are described at the end of this section.

The keys can be separated into three categories, those which affect:

- the system setup, for example the GPIB address.
- the currently selected window setup, for example the measurement units.
- the channel setup, for example channel offsets.

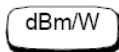

The softkey menu structured to this key affects the currently selected window. Press  to select the upper or lower measurement window on the power meter's display. The window which is selected is highlighted by a shadowed box and the set up you create is implemented in this window.

Press this key to access the “dBm/Watts” menu which allows you to select the measurement units. These can either be logarithmic (dBm or dB) or linear (Watt or %). The default is logarithmic. The text on some softkeys may appear grayed out. This indicates that they are not a relevant unit of measurement in the currently selected window. Refer to [“Setting the Units of Measurement”](#) on page 59 for further information.

- **dBm**  
Press this softkey to display the measurement results in dBm.
- **W**  
Press this softkey to display the measurement results in Watts.
- **dB**  
Press this softkey to display the measurement results in dB.
- **%**  
Press this softkey to display the measurement results in %.



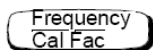





The softkey menu structured to this key affects the channel setup.

Press this key to access the “Frequency/Cal Fac” menu which allows you to enter the frequency of the signal to be measured or the calibration factor. Depending on the type of power sensor connected and whether or not a sensor calibration table or frequency dependent offset table is selected, the text on some softkeys may appear grayed out. This indicates that they are not relevant in the power meter’s current mode of operation. [Table 3-1](#) details the relevant softkeys in various modes of operation.





**Table 3-1** Combination of Sensor Type and Correction Applied to Current Measurement

Sensor Model	Sensor Calibration Table Selected		Sensor Calibration Table Not Selected	
	Frequency Freq	Cal Factor Cal Fac	Frequency Freq	Cal Factor Cal Fac
Agilent 8480 Series power sensors	Frequency can be entered. Default value is 50 MHz.	The Cal Factor is obtained from the sensor calibration table but can be overridden by this softkey.	Frequency can be entered if a frequency dependent offset table is selected.	The Cal Factor can be entered. Default value is 100%.
Agilent E-Series power sensors	Not Applicable	Not Applicable	Frequency can be entered. Default value is 50 MHz.	The Cal Factor cannot be entered, it is obtained from the EEPROM in the power sensor.
Agilent N8480 Series power sensors (excluding Option CFT)	Not Applicable	Not Applicable	Frequency can be entered. Default value is 50 MHz.	The Cal Factor cannot be entered, it is obtained from the EEPROM in the power sensor.
Agilent N8480 Series power sensors with Option CFT	Frequency can be entered. Default value is 50 MHz.	The Cal Factor is obtained from the sensor calibration table but can be overridden by this softkey.	Frequency can be entered if a frequency dependent offset table is selected.	The Cal Factor can be entered. Default value is 100%.

- **Freq**

Press this softkey to enter the frequency of the signal to be measured on channel A, in the range of 0.001 MHz to 999.999 GHz. The default value is 50 MHz. Use the , , , and  keys to change the frequency. To confirm your choice, press the appropriate frequency unit. Entering a frequency using this softkey is only possible when you have a sensor calibration table or frequency dependent offset table selected or you are using an Agilent E-Series power sensor or N8480 Series power sensor (excluding Option CFT).

- **Cal Fac**

Press this softkey to enter the measurement calibration factor for channel A in the range of 1% to 150%. The default value is 100%. Use the , , , and  keys to change the calibration factor. To confirm your choice, press **%**. Entering a calibration factor using this softkey is only possible when you are using an Agilent 8480 Series power sensor or N8480 Series power sensor with Option CFT .



The softkey menu structured to this key affects the currently selected window. Press  to select the upper or lower measurement window on the power meter's display. The window which is selected is highlighted by a shadowed box and the set up you create is implemented in this window.

Press this key to access the "Meas Setup" menu. This menu allows you to set up a variety of conditions in the currently selected measurement window, for example: an analog or digital display, measurement limits, resolution and channel selection.

- **Display Format**

Press this softkey to access a menu which allows you to select digital or analog displays, set the resolution and set the limits for the analog display.

- **Meter Dgtl Anlg**

Press this softkey to toggle between an analog and digital display. Refer to "Selecting a Digital or Analog Display" on page 76 for further information.

- **Anlg Mtr Scaling**

Press this softkey to access a menu which allows you to enter the maximum and minimum scale limits shown on the analog display.

- **Max**

Press this softkey to enter the maximum scale value shown on the analog display.

- **Min**

Press this softkey to enter the minimum scale value shown on the analog display.

- **Resolution 1 2 3 4**

Press this softkey to choose from four levels of resolution. The resolution can be specified in dB or digits depending on the measurement suffix used. The suffix used is the one which is selected in the **dBm/W** menu. These four levels (1, 2, 3, 4) represent:

1, 0.1, 0.01, 0.001 dB respectively if the measurement suffix is dBm or dB.  
1, 2, 3, or 4 significant digits respectively if the measurement suffix is W or %.

The default value is 3 (that is, 0.01 dB or 3 digits).





- **Limits**

Press this softkey to access a menu where you can enter upper and lower limits for each display window which when exceeded will output a TTL logic level (if enabled) at the rear panel TTL outputs. Refer to [“Setting Window Limits”](#) on page 72 for further information.





- **Limits Off On**

Press this softkey to toggle between the test limits being on or off. The default is “Off”.

- **Max**

Press this softkey to enter the upper measurement limit. The measurement units of the limits will be the same as the measurement units in the currently selected window. On instrument preset, the default value is either 90.000 dBm, 1 mW, 60 dB, or 100M% depending on the windows unit. Use the , , , and  keys to change the value. To confirm your choice, press the appropriate measurement units. **Max** must be greater than **Min**.

- **Min**

Press this softkey to enter the lower measurement limit. The measurement units of the limits will be the same as the measurement units in the currently selected window. On instrument preset, the default value is either -90.000 dBm, 1 pW, -120 dB, or 100p% depending on the windows unit. Use the , , , and  keys to change the value. To confirm your choice, press the appropriate measurement units. **Min** must be less than **Max**.

- **TTL Output**

Press this softkey to access a menu which allows you to control the rear panel TTL outputs. You can:

Switch the TTL outputs on or off.

Set the TTL output level to active high or low.

Determine whether the TTL output represents an over limit condition, under limit condition or both.

- **TTL Output Off On**

Press this softkey to toggle between switching the TTL output off and on.



- **Limits OVER UNDER EITHER**

Press this softkey to select whether the TTL output reflects an overlimit condition, under limit condition or both.

- **Fail O/P HIGH LOW**

Press this softkey to select whether a high or low level TTL output represents a limits failure.



Press this key to move through all the softkeys available on a particular level of a menu. The bottom right of the power meter display indicates the number of pages in the menu. For example, if “1 of 2” is displayed, pressing  moves you to “2 of 2”. Pressing  again moves you back to “1 of 2”.



Press this key to preset the power meter if you are currently working in local mode (that is, front panel operation). A confirmation pop-up window is displayed prior to a preset being carried out. Presetting the power meter returns you to the “Contrast” menu. However, if you are in remote mode (that is, GPIB operation), then pressing this key places the power meter in local mode provided local lock out (LLO) is not enabled. When reverting to local mode, the power meter triggering is set to free run.

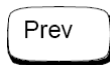

Press this key to move back one level in the softkey menu structure. Pressing this key numerous times eventually returns you to the “Contrast” menu which allows you to increase or decrease the display contrast.



Press this softkey to increase the display contrast.



Press this softkey to decrease the display contrast.

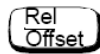

The softkey menu structured to this key affects the currently selected window.

Press this key to access the “Rel/Offset” menu which allows you to; compare any measurement result in dB or percentage (%) to a reference value and set display offsets.



Press this softkey to toggle the reference value on or off. The default is “Off”. The reference value is set using **Rel**.







Press this softkey to use the current reading as the reference value. This allows you to compare any measurement result in dB or percentage (%). **Rel Off On** is automatically set to “On” when **Rel** is pressed.

- **Offset Off On**

Press this softkey to toggle the display offset value on or off. The default is “Off”. The offset value is set using **Offset**.

- **Offset**

Press this softkey to enter a display offset value. Use the , , , and  keys to change the value. To confirm your choice, press **dB**.

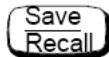

**Offset Off On** is automatically set to “On” when a value is entered using **Offset**.





The softkey menu structured to this key affects the system setup.

Press this key to access the “Save/Recall” menu and screen which allows you to save and recall setups which you use frequently.







- **Save**

Press this softkey to save the current setup of the power meter to the highlighted file. First, use the  and  keys to scroll through the displayed files. When the required file is highlighted, press **Save**.

- **Recall**

Press this softkey to recall a required power meter setup from the highlighted file. First, use the  and  keys to scroll through the displayed files. When the required file is highlighted, press **Recall**.

- **Edit Name**

Press this softkey to change a file name. First, use the  and  keys to scroll between the displayed files. When the file name you require to change is highlighted, press **Edit Name**. A pop-up window appears on the screen. Use the , , , , **Insert Char**, and **Delete Char** keys to change the file name. To confirm your choice, press **Enter**.

- **Enter**

Press this softkey to accept your edited file name as a new name.

- **Insert Char**  
Press this softkey to insert an additional character. The character is inserted prior to the one which is currently highlighted. A maximum of 12 characters can be used.
- **Delete Char**  
Press this softkey to delete the character which is currently highlighted. The minimum number of characters allowed is 1.
- **Cancel**  
Press this softkey to revert back to the original file name, ignoring your editing.
- **Done**  
Press this softkey to return to the measurement screen.

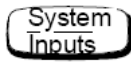

The softkey menu structured to this key affects the system setup and the channel setup.

Press this key to access the “System/Inputs” menu. This menu allows you to set up a variety of conditions for your power meter, for example: GPIB address, serial interface parameters, sensor calibration tables, averaging, duty cycle, range, offset, service. It also allows you to review errors.

- **Remote Interface**  
Press this softkey to access a menu which allows you to select and configure the remote interface, select the command set you want to use or obtain an interface overview.
- **Command Set**  
Press this softkey to access a menu which allows you to select the remote programming language you want to use. Refer to [“Programming Language Selection”](#) on page 85 for further information.
  - **SCPI**  
Press this softkey to select SCPI (Standard Commands for Programmable Instruments) as the remote programming language you want to use.

- **HP 437B**

Press this softkey to select the Agilent 437B emulation mode. In this mode, the power meter responds to the Agilent 437B programming command set.

- **Select Interface**

Press this softkey to access a menu which allows you to select between GPIB, RS232 and RS422 as the remote interface standard.

- **GPIB**

Press this softkey to select the GPIB port for remote operation.

- **RS232**

Press this softkey to select the serial port for remote operation using the RS232 Standard.

- **RS422**

Press this softkey to select the serial port for remote operation using the RS422 Standard.





- **Configure Interface**

Press this softkey to access a menu which allows you to either configure the GPIB interface or the serial interface (RS232/RS422).

- **GPIB**

Press this softkey to access a menu which allows you to set the GPIB address.

- **GPIB Addr**

Press this softkey to set the GPIB address of your power meter between 0 and 30. The default value is 13. A pop-up window appears on the screen. Use the , , , and  keys to change the value. To confirm your choice, press **Enter**.

Refer to “GPIB Address” on page 80 for further information.

- **Serial**

Press this softkey to access a menu which allows you to set baud rate, word size, parity, number of stop bits, pacing and echo for the serial interface.



- **Baud Rate**  
Press this key to set the serial interface baud rate. The default value is 9600. A pop-up window appears on the screen giving a range of values (50, 75, 110, 150, 300, 1200, 1800, 2000, 2400, 3600, 4800, 7200, 9600, 19.2K, 38.4K, 57.6K, or 115.2K).
- **Word Size**  
Press this softkey to set the serial interface word length. A pop-up window appears on the screen giving a selection of seven or eight.
- **Stop Bits**  
Press this softkey to set the serial interface number of stop bits. A pop-up window appears on the screen giving a selection of one or two.
- **Parity**  
Press this softkey to enable or disable parity and set the parity type for the serial interface. A pop-up window appears on the screen allowing you to select from ODD, EVEN, ZERO, ONE or NONE.
- **Pacing**  
Press this softkey to access a menu which allows you to enable or disable various hardware and software pacing options.
  - ◆ **Tx Pacing**  
Press this softkey to toggle between enabling and disabling the Xon/Xoff transmitter software handshake. When enabled “Xon” is highlighted, otherwise “None” is highlighted.
  - ◆ **Rx Pacing**  
Press this softkey to toggle between enabling and disabling the Xon/Xoff receiver software handshake. When enabled, “Xon” is highlighted, otherwise “None” is highlighted.
  - ◆ **RTS/CTS**  
Press this softkey to obtain a pop-up window which allows you to select one of the following:
    - OFF - Sets the RTS signal line permanently low.
    - ON - Sets the RTS signal line permanently high.

IBFull - Sets the RTS signal line high while the receiver buffer can accept more data and sets RTS low when the data buffer is full. The transmitter is inhibited when CTS is low.

- ◆ **DTR/DSR**

Press this softkey to obtain a pop-up window which allows you to select one of the following:

OFF - Sets the DTR signal line permanently low.

ON - Sets the DTR signal line permanently high.

IBFull - Sets the DTR signal line high while the receiver buffer can accept more data and sets DTR low when the data buffer is full. The transmitter is inhibited when DSR is low.

This key is greyed out if RS422 interface is selected.



- **Echo**

Press this softkey to toggle Echo “On” or “Off”. When Echo is enabled, received characters are transmitted back to the sender.





- **Tables**

Press this softkey to access a menu which allows you to select between sensor calibration tables and frequency dependent offset tables.





- **Sensor Cal Tables**

Press this softkey to access a menu and screen which allows you to select and edit sensor calibration tables. Use the  and  keys to scroll through the displayed sensor calibration tables. Sensor calibration tables are only required for the Agilent 8480 Series power sensors and N8480 Series power sensors with Option CFT.

- **Edit Table**

Press this softkey to access a menu and screen which allows you to modify, add and remove frequency, calibration factors and offsets from the currently selected table and modify the table name. Use the , , , and  keys to move between the name, frequency, calibration factors and offsets. Press **Change**, **Insert**, or **Delete** as follows:

- **Change**

Press this softkey to modify the highlighted parameter, which is either a frequency, calibration factor, offset or table name. A pop-up window displays the parameter. Use the , , , and  keys to change the parameter value. To confirm your choice, press **Enter**.

- **Insert**

Press this softkey to insert a new table entry. You are prompted to enter the frequency and calibration factor or offset. The entry is inserted in ascending frequency order.



- **Delete**

Press this softkey to delete a table entry. If you delete the frequency, the corresponding calibration factor or offset is also removed and vice versa.





- **Done**

Press this softkey to return to the measurement screen. The softkeys from the first level of the “System/Inputs” menu are displayed.





- **Freq Dep Offset**

Press this softkey to access a menu and screen which allows you to select and edit frequency dependent offset tables. Use the  and  keys to scroll through the displayed frequency dependent offset tables.

- **Edit Table**

Press this softkey to access a menu and screen which allows you to modify, add and remove frequency, calibration factors and offsets from the currently selected table and modify the table name. Use the , , , and  keys to move between the name, frequency, calibration factors and offsets. Press **Change**, **Insert**, or **Delete** as follows:

- **Change**

Press this softkey to modify the highlighted parameter, which is either a frequency, calibration factor, offset or table name. A pop-up window displays the parameter. Use the , , , and  keys to change the parameter value. To confirm your choice, press **Enter**.

- **Insert**

Press this softkey to insert a new table entry. You are prompted to enter the frequency and calibration factor or offset. The entry is inserted in ascending frequency order.
- **Delete**

Press this softkey to delete a table entry. If you delete the frequency, the corresponding calibration factor or offset is also removed and vice versa.
- **Done**

Press this softkey to return to the measurement screen. The softkeys from the first level of the “System/Inputs” menu are displayed.
- **Table Off Or**

Press this softkey to enable and disable the highlighted table for channel A. “ON” or “OFF” is displayed beside each table to indicate its current state.
- **Done**

Press this softkey to return to the measurement screen. The softkeys from the first level of the “System/Inputs” menu are displayed.
- **Linearity AType DType**





Press this softkey to select the type of linearity correction that will be applied to the sensor being used. For most 8480 series sensors, the correct (A type or D type) linearity correction table is automatically selected. However, for the V8486A and W8486A sensors, the automatic selection must be overridden and the D type correction selected. Subsequent connection of another A type sensor will result in a warning message stating that “Linearity Override May be Required”.
- **Input Settings**

Press these softkeys to access a menu which allows you to modify the settings of the averaging, duty cycle, range and offset of channel A.



  - **Offset Off On**

Press this softkey to toggle the channel offset value on or off. The default is “Off”. The offset value is set using **Offset**.

- **Offset**

Press this softkey to enter a channel offset in the range of -100 dB to +100 dB. The default value is 0 dB. Use the , , , and  keys to change the value. To confirm your choice, press **dB**. This offset can be used to compensate for a loss or gain. The offset is applied to the measured power before the result is displayed. **Offset Off On** is automatically set to “On” when a value is entered using **Offset**. Refer to “[Setting Channel Offsets](#)” on page 63 for further information.

- **Range** (Agilent E-Series power sensors or N8480 Series power sensors (excluding Option CFT) only)

Press this softkey to set the range in which you require the power meter to make the power measurement or set the power meter to autoranging. Choose either “UPPER”, “LOWER” or “AUTO” from the selection available using the  and  keys. The default is “AUTO”. Refer to “[Setting the Range](#)” on page 79 for further information.





- **Limits**

Press this softkey to access a menu which allows you to enter the upper and lower measurement limits. Refer to “[Setting Measurement Limits](#)” on page 70 for further information.





- **Limits Off Or**

Press this softkey to toggle between the test limits being on or off. The default is “Off”.

- **Max**

Press this softkey to enter the upper measurement limit in the range -150 dBm to 230 dBm. The default value is 90.00 dBm. Use the , , , and  keys to change the value. To confirm your choice, press the appropriate measurement units. **Max** must be greater than **Min**.





- **Min**

Press this softkey to enter the lower measurement limit in the range -150 dBm to 230 dBm. The default value is -90.00 dBm. Use the , , , and  keys to change the value. To confirm your choice, press the appropriate measurement units. **Min** must be less than **Max**.

- **Duty Cycle Off Or**

Press this softkey to toggle the duty cycle value on or off. The default is “Off”. The duty cycle value is set using **Duty Cycle**.

- **Duty Cycle**

Press this softkey to set the duty cycle for the pulse power measurement feature of the power meter. A value in the range of 0.001% to 100% can be entered. The default value is 1.000%. Use the , , , and  keys to change the value. To confirm your choice press **%**.

**Duty Cycle Off On** is automatically set to “On” when a value is entered using **Duty Cycle**. Refer to “[Measuring Pulsed Signals](#)” on page 68 for further information.

- **Filter**

Press this softkey to access a menu which allows you to switch the filter off and on, set the filter length, select automatic or manual mode and switch step detection off and on.





- **Filter Off On**

Press this softkey to toggle the filter value on or off. The default is “On”. The filter value is set using **Length**

- **Mode AUTO MAN**

Press this softkey to toggle between the automatic (AUTO) and manual (MAN) filter modes. In manual mode, you enter the number of measurements to be averaged. In automatic mode, the number of measurements averaged is based on the measured power and uses a pre-defined look-up table. Refer to “[Setting Averaging](#)” on page 65 for further information.

- **Length**

Press this softkey to enter the filter length. The filter is used to reduce noise, obtain the desired resolution and to reduce jitter in the measurement results. Use the , , , and  keys to change the value.

- **Step Det Off On**

Press this softkey to switch step detection on or off. Step detection reduces the settling time of the filter by re-initialising the filter after a significant step (increase or decrease) has been detected in the measured power. The default is “On”.

- **Power Ref Off On**

Press this softkey to switch the POWER REF output on or off. This output is used as the signal source for calibration. This softkey is commonly used for troubleshooting. The default is “Off”.

## NOTE

During calibration, the power meter automatically switches the power reference oscillator on (if it is not already on), then after calibration, it switches it to the state it was in prior to the calibration.

- **Error List**

Press this softkey to display any power meter errors and access a menu which allows you to clear and scroll through any power meter errors. The errors are viewed in a first in first out (FIFO) basis.

- **Clear Errors**

Press this softkey to clear all the errors which are stored in the power meter’s memory.

- **Next**

Press this softkey to move to the next error in the error queue. The displayed error message is individually cleared each time **Next** is selected.

- **Done**

Press this softkey to return to the “System/Inputs” menu.

- **Recorder Output**

Press this softkey to access a menu which allows you to modify the setup of the recorder output. Refer to “[Recorder Output](#)” on page 86 for further information.

- **Output Off On**

Press this softkey to switch the rear panel Recorder Output on or off. The Recorder Output produces a DC voltage that corresponds to the selected input channel power level in Watts.

- **Max Power**

Press this softkey to enter the input power level that you want to represent the 1 Vdc maximum output voltage of the Recorder Output.

- **Min Power**

Press this softkey to enter the input power level that you want to represent the 0 Vdc minimum output voltage of the Recorder Output.

- **Service**

Press this softkey to access a menu which allows you to test and service your power meter.

- **Self Test**

Press this softkey to access the power meter's self test menu.

- **Instrument Self Test**

Press this softkey to run a series of tests on the power meter. Refer to "[Instrument Self Test](#)" on page 96 for further information on the tests run.

- **Confidence Check**

Press this softkey to verify that the power meter makes an accurate measurement of its 1 mW POWER REF output.

- **Individual**

Press this softkey to access a menu which allows you to select individual self tests to be run.

- **Memory**

Press this softkey to perform a ROM Checksum verification test, verify the memory and that the correct amount of RAM is present.

- **Lithium Battery**

Press this softkey to verify that the firmware checksum is still resident in a battery-backed memory location.

- **Measure Assembly**

Press this softkey to run a self test on the measurement assembly. Refer to "[Measurement Assembly](#)" on page 98 for further information.

- **Calibrator**

Press this softkey to make internal voltage measurements on the 50 MHz reference oscillator.

- **Keyboard**



Press this softkey to verify that the keys are functioning correctly. Once you enter this test, you are prompted to press all the keys and verify the correct descriptions are displayed on the screen.

- **Fan**

Press this softkey to run a test on the internal cooling fan.

- **Display**

Press this softkey to access a menu of various front panel display patterns.

- **Display Assy**

Press this softkey to make internal measurements on the display.

- **Display RAM**

Press this softkey to perform a display RAM read or write test.

- **Bitmap Displays**

Press this softkey to display test patterns. Instructions appear on the screen detailing the use of **More** to cycle through the various bitmaps and **Prev** to end the displays.

- **Serial Interface**

Press this softkey to access a menu which gives you a selection of serial interface tests to perform.

- **UART Config**

Press this softkey to initiate a test which writes to the scratch register and reads back. The test also sets the baud rate, word length, stop bits and parity; then reads back from the UART to check that the settings are correct.

- **Local Loop Back**

Press this softkey to initiate a UART local loop back diagnostic with the transmitter (Tx) internally connected to the receiver (Rx).

- **RS232 Loop Back**

Press this softkey to initiate an RS232 loop back test on the serial interface port. A pop-up message appears stating that a test connector must be in place. The test connector must have the following pins jumpered: Tx (3) and Rx (2), RTS (7) and CTS (8), DTR (4) and DSR (6).

This test will only run if the RS232 interface is currently selected.

A softkey menu offers the following choices:

Run Test - performs the RS232 loop back test and reports the results.

Cancel Test - quit test and return to previous menu.

- **RS422 Loop Back**

Press this softkey to initiate an RS422 loop back test on the serial interface port. A pop-up message appears stating that a test connector must be in place. The test connector must have the following pins jumpered: Tx- (4) and Rx- (2), Tx+(3) and Rx+(6), RTS-(9) and CTS-(1), RTS+(7) and RTS-(8).

This test will only run if the RS422 interface is currently selected.

A softkey menu offers the following choices:

Run Test - performs the RS422 loop back test and reports the results.

Cancel Test - quit test and return to previous menu.

- **Display**

Press this softkey to access a menu which allows you to set the defaults for contrast and brightness.



Press this softkey to increase the display contrast.



Press this softkey to decrease the display contrast.

- **Set Contrast**

Press this softkey to set the default contrast to that currently displayed. Note, this key changes the factory default setting.

- **Set Brightness**

Press this softkey to set the brightness. Note, this key changes the factory default setting.

- **Version**

Press this softkey to display: the model number; option structure; serial number; firmware, bootrom and DSP revisions.

- **Serial Diagnostic**

Press this softkey to access a diagnostic menu for the serial interface (RS232/RS422). This softkey is greyed out if GPIB has been selected as the remote control interface.

- **Tx Break**

Press this softkey to transmit a break sequence from the serial port to the external receiver.

- **Status**

Press this softkey to produce a screen showing the state of the UART line and modem status registers. If the Xon/Xoff handshake is enabled, the screen also shows the state of Rx and Tx.

- **Reset**

Press this softkey to reset and initialize the UART and to flush both the receiver and transmitter buffers.

- **Interface Overview**

Press this softkey to produce a screen showing a summary of the remote interface configuration.

- **Battery**

This softkey is only present on power meters fitted with the battery Option 001. It is greyed out when the battery is not installed.

Press this softkey to produce a screen which shows:

- How much charge the battery is holding
- The approximate running time left under battery power.
- Either, “Using AC power” (if the battery is fully charged), “Charging battery” or “Using battery power” as applicable.

This softkey also accesses the Battery menu which allows you to set the display backlight to On, Off or Timed mode. In Timed mode, the backlight turns off 10 minutes after the last key is pressed. To turn the backlight on again, press any key. While operating with AC power connected, these keys are grayed out and the backlight is permanently on. On instrument preset, the Backlight is set to “On”

- **Backlight On**

Press this softkey to turn the display backlight permanently On.

- **Backlight Off**

Press this softkey to set the display backlight to be Off while the power meter is operating under battery power.

- **Backlight Timed**

Press this softkey to select the Backlight Timed mode. When the power meter is in this mode and is operating under battery power, the display backlight turns off 10 minutes after the last key press. To turn the backlight back on, press any key.

- **Done**

Pressing this softkey returns the display to the previous screen.



The softkey menu structured to this key affects the channel setup.

Press this key to access the “Zero/Cal” menu which allows you to zero and calibrate the power meter. Refer to “[Calibrating the Power Meter](#)” on page 30 for further information.





- **Zero**

Press this softkey to adjust channel A for a zero power reading with no power applied to the power sensor. Refer to “[Zeroing and Calibrating the Power Meter](#)” on page 29 for further information.

- **Cal**

Press this softkey to calibrate channel A with the connected power sensor. The POWER REF output is used as the signal source for calibration and is automatically switched on during this procedure.

- **Ref CF**

Press this softkey to enter a reference calibration factor for channel A. A value in the range of 1% to 150% can be entered. The default value is obtained from the sensor calibration table if one is selected, otherwise it is 100%. Use the , ,  and  keys to change the value. To

confirm your choice, press **%**. This softkey cannot be selected when you are using an Agilent E-Series power sensor or N8480 Series power sensor (excluding Option CFT).

- **Power Ref Off On**

Press this softkey to switch the POWER REF output on or off. This output is used as the signal source for calibration. The default is “Off”.

**NOTE**

During calibration the power meter automatically switches the power reference oscillator on (if it is not already on), then after calibration, it switches it to the state it was in prior to the calibration.

- **Must Cal Off Or**

Press this softkey to switch the Zero/Cal Lockout facility On or Off. When Zero/Cal Lockout is On, the power meter is prevented from making a measurement until the sensor connected has been zeroed and calibrated. This softkey is coupled to the equivalent softkey in the System Inputs menu.

- **TTL Inputs Off On**

Press this softkey to disable or enable (Off/On) the ZERO and CAL rear panel TTL inputs.

## Diagrammatical keys



Press this key to:

- assist in modifying alphanumeric data that is to be entered into the power meter. This key moves the position of the cursor to the left on the currently selected parameter.
- select fields for editing on the “Edit Table” screen.



Press this key to:

- assist in modifying alphanumeric data that is to be entered into the power meter. This key moves the position of the cursor to the right on the currently selected parameter.
- select fields for editing on the “Edit Table” screen.



Press this key to:



- decrement the alphanumeric digit on which the cursor is currently positioned. That is, digits scroll 9 through 0 and characters lowercase z through a, uppercase Z through A, then underscore.
- select fields for editing on the “Edit Table” screen.
- select a table in the “Sensor Cal Tables” screen.
- select a file in the “Save” and “Recall” screens.



Press this key to:

- increment the alphanumeric digit on which the cursor is currently positioned. That is, digits scroll 0 through 9 and characters lowercase a through z, uppercase A through Z, then underscore.
- select fields for editing on the “Edit Table” screen.
- select a table in the “Sensor Cal Tables” screen.
- select a file in the “Save” and “Recall” screens.



Press this key to select the upper or lower measurement window on the power meter’s display. The window which is selected is highlighted by a shadowed box. Any measurement setup you create using ,  and  is implemented in the selected window.



Press this key to choose from a one or a two window display.



Press this key to switch the power meter between on and standby. When the power meter is switched to standby (that is, when this key is off but the power is connected to the instrument) the red LED is lit. When the power meter is switched on, the green LED is lit.

**THIS PAGE HAS BEEN INTENTIONALLY LEFT BLANK.**





## 4 Error Messages

Introduction 146

Error Messages 148



## Introduction

This chapter contains information about the power meter's error messages. It explains how to read the power meter's error queue and lists all of the power meter's error messages and their probable causes.

When there is a hardware related problem, for example, a power sensor overload, the error message is displayed on the status line at the top of the display. In addition, the errors are also written to the error queue. If there are any errors in the error queue, the front panel error annunciator is displayed as shown in [Figure 4-1](#).

Other errors can also be generated when the power meter is being operated over the remote interface. These errors also display the error annunciator and are written to the error queue.

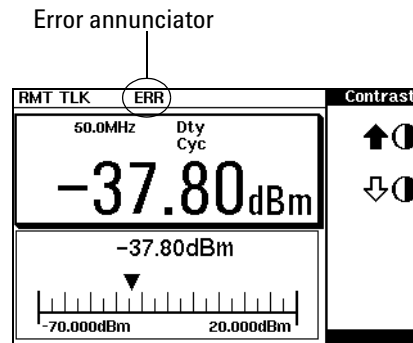

**Figure 4-1** Error Annunciator Position

To read the error queue from the front panel press:

- **System Inputs**, **More**, **Error List** then use **Next** to scroll through each error message.

To read the error queue from the remote interface use:

- the `SYSTEM:ERROR?` command.

Error queue messages have the following format:

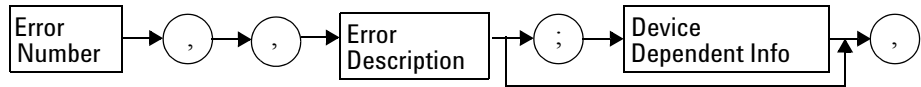

For example, -330, "Self-test Failed;Battery Fault".

Errors are retrieved in a first in first out (FIFO) order. If more than 30 errors occur, the error queue overflows and the last error in the queue is replaced with error -350, "Queue Overflow". Any time the queue overflows, the most recent error is discarded.

Once the errors are read, they are removed from the error queue. This opens a position at the end of the queue for a new error message, if one is subsequently detected. When all errors have been read from the queue, further error queries return +0, "No errors".

To delete all the errors in the queue from the front panel press:

- **System Inputs**, **More**, **Error List** then **Clear Errors**.

To delete all the errors in the queue, remotely use:

- the \*CLS (clear status) command.

The error queue is also cleared when the instrument power has been switched off.

# Error Messages

- 101           **Invalid character**  
An invalid character was found in the command string. You may have inserted a character such as #, \$ or % in the command header or within a parameter.  
For example, LIM:LOW 0#.
- 102           **Syntax error**  
Invalid syntax was found in the command string.  
For example, LIM:CLE:AUTO, 1 or LIM:CLE: AUTO 1.
- 103           **Invalid separator**  
An invalid separator was found in the command string. You may have used a comma instead of a colon, semicolon or blank space; or you may have used a blank space instead of a comma.  
For example, OUTP:ROSC, 1.
- 105           **GET not allowed**  
A Group Execute Trigger (GET) is not allowed within a command string.
- 108           **Parameter not allowed**  
More parameters were received than expected for the command. You may have entered an extra parameter or added a parameter to a command that does not accept a parameter.  
For example, CAL 10.
- 109           **Missing parameter**  
Fewer parameters were received than expected for the command. You omitted one or more parameters that are required for this command. For example, AVER:COUN.
- 112           **Program mnemonic too long**  
A command header was received which contained more than the maximum 12 characters allowed.  
For example, SENSEAVERAgeCOUNt 8.
- 113           **Undefined header**  
A command was received that is not valid for this power meter. You may have misspelled the command, it may not be a valid command or you may have the wrong interface selected. If you are using the short form of the command, remember that it may contain up to four letters.  
For example, TRIG:SOUR IMM.
- 121           **Invalid character in number**  
An invalid character was found in the number specified for a parameter value.  
For example, SENS:AVER:COUN 128#H.

- 123           **Exponent too large**  
A numeric parameter was found whose exponent was larger than 32,000.  
For example, SENS : COUN 1E34000.
- 124           **Too many digits**  
A numeric parameter was found whose mantissa contained more than 255 digits, excluding leading zeros.
- 128           **Numeric data not allowed**  
A numeric value was received within a command which does not accept a numeric value.  
For example, MEM : CLE 24.
- 131           **Invalid suffix**  
A suffix was incorrectly specified for a numeric parameter. You may have misspelled the suffix.  
For example, SENS : FREQ 200KZ.
- 134           **Suffix too long**  
A suffix used contained more than 12 characters.  
For example, SENS : FREQ 2MHZZZZZZZZZZZZ.
- 138           **Suffix not allowed**  
A suffix was received following a numeric parameter which does not accept a suffix.  
For example, INIT : CONT 0Hz.
- 148           **Character data not allowed**  
A discrete parameter was received but a character string or a numeric parameter was expected. Check the list of parameters to verify that you have used a valid parameter type.  
For example, MEM : CLE CUSTOM\_1.
- 151           **Invalid string data**  
An invalid string was received. Check to see if you have enclosed the character string in single or double quotes.  
For example, MEM : CLE "CUSTOM\_1.
- 158           **String data not allowed**  
A character string was received but is not allowed for the command. Check the list of parameters to verify that you have used a valid parameter type.  
For example, LIM : STAT 'ON'.
- 161           **Invalid block data**  
A block data element was expected but was invalid for some reason. For example, \*DDT #15FET. The 5 in the string indicates that 5 characters should follow, whereas in this example there are only 3.
- 168           **Block data not allowed**  
A legal block data element was encountered but not allowed by the power meter at this point.  
For example SYST : LANG #15FETC?.

## 4 Error Messages

- 178           **Expression data not allowed**  
A legal expression data was encountered but not allowed by the power meter at this point.  
For example `SYST:LANG (5+2)`.
- 211           **Trigger ignored**  
Indicates that `<GET>` or `*TRG` or `TRIG:IMM` was received and recognized by the device but was ignored because the power meter was not in the wait for trigger state.
- 213           **Init ignored**  
Indicates that a request for a measurement initiation was ignored as the power meter was already initiated.  
For example, `INIT:CONT ON`  
`INIT.`
- 214           **Trigger deadlock**  
`TRIG:SOUR` was set to `HOLD` or `BUS` and a `READ?` or `MEASure?` was attempted, expecting `TRIG:SOUR` to be set to `IMMediate`.
- 220           **Parameter error;Frequency list must be in ascending order.**  
Indicates that the frequencies entered using the `MEMory:TABLE:FREQuency` command are not in ascending order.
- 221           **Settings conflict**  
This command occurs under a variety of conflicting conditions. The following list gives a few examples of where this error may occur:
- If the `READ?` parameters do not match the current settings.
  - If you are in fast mode and attempting to switch on for example, averaging, duty cycle or limits.
  - Trying to clear a sensor calibration table when none is selected.
- 221           **Settings conflict;DTR/DSR not available on RS422**  
DTR/DSR is only available on the RS232 interface.
- 222           **Data out of range**  
A numeric parameter value is outside the valid range for the command. For example, `SENS:FREQ 2KHZ.`
- 224           **Illegal parameter value**  
A discrete parameter was received which was not a valid choice for the command. You may have used an invalid parameter choice.  
For example, `TRIG:SOUR EXT.`
- 226           **Lists not same length**  
This occurs when `SENSe:CORREction:CSET[1] | CSET2:STATe` is set to `ON` and the frequency and calibration/offset lists do not correspond in length.

- 230           **Data corrupt or stale**  
This occurs when a FETC? is attempted and either a reset has been received or the power meter state has changed such that the current measurement is invalidated (for example, a change of frequency setting or triggering conditions).
- 230           **Data corrupt or stale;Please zero and calibrate Channel A**  
When CAL [ 1 | 2 ] : RCAL is set to ON and the sensor currently connected to channel A has not been zeroed and calibrated, then any command which would normally return a measurement result (for example FETC?, READ? or MEAS?) will generate this error message.
- 230           **Data corrupt or stale;Please zero Channel A**  
When CAL [ 1 | 2 ] : RCAL is set to ON and the sensor currently connected to channel A has not been zeroed, then any command which would normally return a measurement result (for example FETC?, READ? or MEAS?) will generate this error message.
- 230           **Data corrupt or stale;Please calibrate Channel A**  
When CAL [ 1 | 2 ] : RCAL is set to ON and the sensor currently connected to channel A has not been calibrated, then any command which would normally return a measurement result (for example FETC?, READ? or MEAS?) will generate this error message
- 231           **Data questionable;CAL ERROR**  
Power meter calibration failed. The most likely cause is attempting to calibrate without applying a 1 mW power to the power sensor.
- 231           **Data questionable;Input Overload**  
The power input to Channel A exceeds the power sensor's maximum range.
- 231           **Data questionable;Lower window log error**  
This indicates that a difference measurement in the lower window has given a negative result when the units of measurement were logarithmic.
- 231           **Data questionable;Upper window log error**  
This indicates that a difference measurement in the upper window has given a negative result when the units of measurement were logarithmic.
- 231           **Data questionable;ZERO ERROR**  
Power meter zeroing failed. The most likely cause is attempting to zero when some power signal is being applied to the power sensor.
- 241           **Hardware missing**  
The power meter is unable to execute the command because either no power sensor is connected or it expects an Agilent E-Series or N8480 Series power sensor, and one is not connected.

## 4 Error Messages

- 310 **System error;Dty Cyc may impair accuracy with ECP sensor**  
This indicates that the sensor connected is for use with CW signals only.
- 310 **System error;Sensor EEPROM Read Failed - critical data not found or unreadable**  
This indicates a failure with your Agilent E-Series or N8480 Series power sensor. Refer to your power sensor manual for details on returning it for repair.
- 310 **System error;Sensor EEPROM Read Completed OK but optional data block(s) not found or unreadable**  
This indicates a failure with your Agilent E-Series or N8480 Series power sensor. Refer to your power sensor manual for details on returning it for repair.
- 310 **System error;Sensor EEPROM Read Failed - unknown EEPROM table format**  
This indicates a failure with your Agilent E-Series or N8480 Series power sensor. Refer to your power sensor manual for details on returning it for repair.
- 310 **System error;Sensor EEPROM < > data not found or unreadable**  
Where < > refers to the sensor data block covered, for example, Linearity, Temp - Comp (temperature compensation).  
This indicates a failure with your Agilent E-Series or N8480 Series power sensor. Refer to your power sensor manual for details on returning it for repair.
- 310 **System error;Option 001 Battery charger fault**  
The power meter is connected to an AC power source, the battery is not fully charged and it is not charging.
- 310 **System error;Sensors connected to both front and rear inputs.**  
You cannot connect two power sensors to the one channel input. In this instance, the power meter detects power sensors connected to both its front and rear channel inputs.
- 320 **Out of memory**  
The power meter required more memory than was available to run an internal operation.
- 330 **Self-test Failed;**  
The -330, "Self-test Failed" errors indicate that you have a problem with your power meter. Refer to "[Contacting Agilent Technologies](#)" on page 103 for details of what to do with your faulty power meter.
- 330 **Self-test Failed;Measurement Channel Fault**  
Refer to "[Measurement Assembly](#)" on page 98 if you require a description of the Measurement Assembly test.
- 330 **Self-test Failed;Option 001 Battery requires replacement**  
The Option 001 battery is not charging to a satisfactory level and should be replaced.



- 330           **Self-test Failed;RAM Battery Fault**  
Refer to “[RAM Battery](#)” on page 98 if you require a description of the battery test.
- 330           **Self-test Failed;Calibrator Fault**  
Refer to “[Calibrator](#)” on page 99 if you require a description of the calibrator test.
- 330           **Self-test Failed;ROM Check Failed**  
Refer to “[ROM Checksum](#)” on page 98 if you require a description of the ROM Checksum test.
- 330           **Self-test Failed;RAM Check Failed**  
Refer to “[RAM](#)” on page 98 if you require a description of the RAM test.
- 330           **Self-test Failed;Display Assy. Fault**  
Refer to “[Display](#)” on page 99 if you require a description of the Display test.
- 330           **Self-test Failed;Confidence Check Fault**  
Refer to “[Confidence Check](#)” on page 96 if you require a description of this test.
- 330           **Self-test Failed;Serial Interface Fault**  
Refer to “[Serial Interface](#)” on page 99 if you require a description of this test.
- 350           **Queue overflow**  
The error queue is full and another error has occurred which could not be recorded.
- 361           **Parity error in program**  
The serial port receiver has detected a parity error and consequently, data integrity cannot be guaranteed.
- 362           **Framing error in program**  
The serial port receiver has detected a framing error and consequently, data integrity cannot be guaranteed.
- 363           **Input buffer overrun**  
The serial port receiver has been overrun and consequently, data has been lost.
- 410           **Query INTERRUPTED**  
A command was received which sends data to the output buffer, but the output buffer contained data from a previous command (the previous data is not overwritten). The output buffer is cleared when power has been off or after \*RST (reset) command has been executed.

## 4 Error Messages

- 420           **Query UNTERMINATED**  
The power meter was addressed to talk (that is, to send data over the interface) but a command has not been received which sends data to the output buffer. For example, you may have executed a `CONFigure` command (which does not generate data) and then attempted to read data from the remote interface.
- 430           **Query DEADLOCKED**  
A command was received which generates too much data to fit in the output buffer and the input buffer is also full. Command execution continues but data is lost.
- 440           **Query UNTERMINATED after indefinite response**  
The `*IDN?` command must be the last query command within a command string.



## 5 Specifications

Introduction	156
Power Meter Specifications	157
Power Meter Supplemental Characteristics	161
Battery Option 001 Operational Characteristics	170
General Characteristics	171
Environmental Characteristics	172
General	173



## Introduction

This chapter details the power meter's specifications and supplemental characteristics.

Specifications describe the warranted performance and apply after a 30-minute warm-up. These specifications are valid over the power meter's operating and environmental range unless otherwise stated and after performing a zero and calibration.

Supplemental characteristics, which are shown in italics, are intended to provide information useful in applying the power meter by giving typical, but nonwarranted performance parameters. These characteristics are shown in italics or denoted as "typical", "nominal" or "approximate".

For information on measurement uncertainty calculations, refer to Agilent Application Note 64-1A, "*Fundamentals of RF and Microwave Power Measurements*", Literature Number 5965-6630E.

# Power Meter Specifications

## Meter

### Frequency Range

100 kHz to 110 GHz, power sensor dependent

### Power Range

-70 dBm to +44 dBm (100 pW to 25 W), power sensor dependent

### Power Sensors

Compatible with all Agilent 8480 Series power sensors, Agilent E-Series power sensors and Agilent N8480 Series power sensors.

### Single Sensor Dynamic Range

90 dB maximum (Agilent E-Series power sensors)

50 dB maximum (Agilent 8480 Series power sensors)

55 dB maximum (Agilent N8480 Series power sensors excluding Option CFT)

50 dB maximum (Agilent N8480 Series power sensors with Option CFT)

### Display Units

**Absolute:** Watts or dBm

**Relative:** Percent or dB

### Display Resolution

Selectable resolution of:

1.0, 0.1, 0.01, and 0.001 dB in logarithmic mode or

1, 2, 3, and 4 significant digits in linear mode

### Default Resolution

0.01 dB in logarithmic mode

3 digits in linear mode

## Accuracy

### Instrumentation

**Absolute:**  $\pm 0.02$  dB (Logarithmic) or  $\pm 0.5\%$  (Linear). (Refer to the power sensor linearity specification in your power sensor manual to assess overall system accuracy.)

**Relative:**  $\pm 0.04$  dB (Logarithmic) or  $\pm 1.0\%$  (Linear). (Refer to the power sensor linearity specification in your power sensor manual to assess overall system accuracy.)

**Zero Set (digital settability of zero):** Power sensor dependent (refer to [Table 5-1](#)). For Agilent E-Series, 8480 Series and N8480 Series power sensors, this specification applies when zeroing is performed with the sensor input disconnected from the POWER REF.

**Table 5-1** Zero Set Specifications

Power Sensor	Zero Set
Agilent 8481A <sup>1</sup>	$\pm 50$ nW
Agilent 8481B <sup>1</sup>	$\pm 50$ mW
Agilent 8481D <sup>1</sup>	$\pm 20$ pW
Agilent 8481H <sup>1</sup>	$\pm 5$ mW
Agilent 8482A <sup>1</sup>	$\pm 50$ nW
Agilent 8482B <sup>1</sup>	$\pm 50$ mW
Agilent 8482H <sup>1</sup>	$\pm 5$ mW
Agilent 8483A <sup>1</sup>	$\pm 50$ nW
Agilent 8485A <sup>1</sup>	$\pm 50$ nW
Agilent 8485D <sup>1</sup>	$\pm 20$ pW
Agilent R8486A <sup>1</sup>	$\pm 50$ nW
Agilent R8486D <sup>1</sup>	$\pm 30$ pW
Agilent Q8486A <sup>1</sup>	$\pm 50$ nW
Agilent Q8486D <sup>1</sup>	$\pm 30$ pW
Agilent V8486A <sup>1</sup>	$\pm 200$ nW
Agilent W8486A <sup>1</sup>	$\pm 200$ nW
Agilent 8487A <sup>1</sup>	$\pm 50$ nW
Agilent 8487D <sup>1</sup>	$\pm 20$ pW

Power Sensor	Zero Set
Agilent E4412A	±50 pW
Agilent E4413A	±50 pW
Agilent E9300A	±500 pW
Agilent E9301A	±500 pW
Agilent E9304A	±500 pW
Agilent E9300B	±500 nW
Agilent E9301B	±500 nW
Agilent E9300H	±5 nW
Agilent E9301H	±5 nW
Agilent N8481A (exclude Option CFT) <sup>1</sup>	±25 nW
Agilent N8481B (exclude Option CFT) <sup>1</sup>	±25 μW
Agilent N8481H (exclude Option CFT) <sup>1</sup>	±2.5 μW
Agilent N8482A (exclude Option CFT) <sup>1</sup>	±25 nW
Agilent N8482B (exclude Option CFT) <sup>1</sup>	±25 μW
Agilent N8482H (exclude Option CFT) <sup>1</sup>	±2.5 μW
Agilent N8485A (exclude Option CFT) <sup>1</sup>	±25 nW
Agilent N8486AR (exclude Option CFT) <sup>1</sup>	±25 nW
Agilent N8486AQ (exclude Option CFT) <sup>1</sup>	±25 nW
Agilent N8487A (exclude Option CFT) <sup>1</sup>	±25 nW
Agilent N8488A (exclude Option CFT) <sup>1</sup>	±25 nW
Agilent N8481A with Option CFT <sup>1</sup>	±63 nW
Agilent N8481B with Option CFT <sup>1</sup>	±63 μW
Agilent N8481H with Option CFT <sup>1</sup>	±6.3 μW
Agilent N8482A with Option CFT <sup>1</sup>	±63 nW
Agilent N8482B with Option CFT <sup>1</sup>	±63 μW
Agilent N8482H with Option CFT <sup>1</sup>	±6.3 μW
Agilent N8485A with Option CFT <sup>1</sup>	±63 nW
Agilent N8486AR with Option CFT <sup>1</sup>	±63 nW
Agilent N8486AQ with Option CFT <sup>1</sup>	±63 nW
Agilent N8487A with Option CFT <sup>1</sup>	±63 nW

1 The zero set specifications are tested at 50 MHz.

## 1 mW Power Reference<sup>1</sup>

### Power Output

1.00 mW (0.0 dBm). Factory set to  $\pm 0.4\%$  traceable to National Physical Laboratory (NPL), UK.

### Accuracy (for two years)

$\pm 0.9\%$  (0 to 55 °C)

$\pm 0.6\%$  (25  $\pm$  10 °C)

$\pm 0.5\%$  (23  $\pm$  3 °C)

### SWR<sup>2</sup>

1.06 maximum (1.08 maximum for Option 003)

### Frequency

*50 MHz nominal*

### Connector

Type-N (f), 50  $\Omega$

1. National metrology institutes of member states of the Metre Convention, such as the National Institute of Standards and Technology in the USA, are signatories to the Comité International des Poids et Mesures Mutual Recognition Arrangement. Further information is available from the Bureau International des Poids et Mesures, at <http://www.bipm.fr/>

2. This SWR specification is only warranted for the E4418B and the E4419B Power Meters with serial prefix GB4331xxxx/MYxxxxxxx and above. Prior to this prefix the values shown are supplemental characteristics.



## Power Meter Supplemental Characteristics

### Measurement Speed

*Over the GPIB, three measurement speed modes are available as shown, along with the typical maximum measurement speed for each mode:*

- **Normal:** 20 readings/second
- **x2:** 40 readings/second
- **Fast:** 200 readings/second, for Agilent E- Series power sensors only

*Maximum measurement speed is obtained using binary output in free run trigger mode.*

### Zero Drift of Sensors

Power sensor dependent (refer to [Table 5-3](#)).

## Measurement Noise

Power sensor dependent (refer to [Table 5-2](#) and [Table 5-3](#)).

Averaging effects on measurement noise. Averaging over 1 to 1024 readings is available for reducing noise. [Table 5-3](#) provides the measurement noise for a particular power sensor with the number of averages set to 16 for normal mode and 32 for x2 mode. Use the “Noise Multiplier” for the appropriate mode (normal or x2) and number of averages to determine the total measurement noise value.

For example, for an Agilent 8481D power sensor in normal mode with the number of averages set to 4, the measurement noise is equal to:

$$(<45 \text{ pW} \times 2.75) = <124 \text{ pW}$$

**Table 5-2** Noise Multiplier

Number of Averages	1	2	4	8	16	32	64	128	256	512	1024
<b>Noise Multiplier (Normal Mode)</b>	5.5	3.89	2.75	1.94	1.0	0.85	0.61	0.49	0.34	0.24	0.17
<b>Noise Multiplier (x2 mode)</b>	6.5	4.6	3.25	2.3	1.63	1.0	0.72	0.57	0.41	0.29	0.2

**Table 5-3** Power Sensor Specifications±

Power Sensor	Zero Drift <sup>1</sup>	Measurement Noise <sup>2</sup>
Agilent 8481A <sup>3</sup>	<±10 nW	<110 nW
Agilent 8481B <sup>3</sup>	<±10 mW	<110 mW
Agilent 8481D <sup>3</sup>	<±4 pW	<45 pW
Agilent 8481H <sup>3</sup>	<±1 mW	<10 mW
Agilent 8482A <sup>3</sup>	<±10 nW	<110 nW
Agilent 8482B <sup>3</sup>	<±10 mW	<110 mW
Agilent 8482H <sup>3</sup>	<±1 mW	<10 mW
Agilent 8483A <sup>3</sup>	<±10 nW	<110 nW
Agilent 8485A <sup>3</sup>	<±10 nW	<110 nW
Agilent 8485D <sup>3</sup>	<±4 pW	<45 pW
Agilent R8486A <sup>3</sup>	<±10 nW	<110 nW

<b>Power Sensor</b>	<b>Zero Drift<sup>1</sup></b>	<b>Measurement Noise<sup>2</sup></b>
Agilent R8486D <sup>3</sup>	<±6 pW	<65 pW
Agilent Q8486A <sup>3</sup>	<±10 nW	<110 nW
Agilent Q8486D <sup>3</sup>	<±6 pW	<65 pW
Agilent V8486A <sup>3</sup>	<±40 nW	<450 nW
Agilent W8486A <sup>3</sup>	<±40 nW	<450 nW
Agilent 8487A <sup>3</sup>	<±10 nW	<110 nW
Agilent 8487D <sup>3</sup>	<±4 pW	<45 pW
Agilent E4412A	<±15 pW	<70 pW
Agilent E4413A	<±15 pW	<70 pW
Agilent E9300A	<±150 pW	<700 pW
Agilent E9301A	<±150 pW	<700 pW
Agilent E9304A	<±150 pW	<700 pW
Agilent E9300B	<±150 nW	<700 nW
Agilent E9301B	<±150 nW	<700 nW
Agilent E9300H	<±1.5 nW	<7 nW
Agilent E9301H	<±1.5 nW	<7 nW
Agilent N8481A (exclude Option CFT) <sup>3</sup>	<±3 nW	<80 nW
Agilent N8481B (exclude Option CFT) <sup>3</sup>	<±3 μW	<80 μW
Agilent N8481H (exclude Option CFT) <sup>3</sup>	<±0.3 μW	<8 μW
Agilent N8482A (exclude Option CFT) <sup>3</sup>	<±3 nW	<80 nW
Agilent N8482B (exclude Option CFT) <sup>3</sup>	<±3 μW	<80 μW
Agilent N8482H (exclude Option CFT) <sup>3</sup>	<±0.3 μW	<8 μW
Agilent N8485A (exclude Option CFT) <sup>3</sup>	<±3 nW	<80 nW
Agilent N8486AR (exclude Option CFT) <sup>3</sup>	<±3 nW	<80 nW
Agilent N8486AQ (exclude Option CFT) <sup>3</sup>	<±3 nW	<80 nW

## 5 Specifications

<b>Power Sensor</b>	<b>Zero Drift<sup>1</sup></b>	<b>Measurement Noise<sup>2</sup></b>
Agilent N8487A (exclude Option CFT) <sup>3</sup>	$<\pm 3 \text{ nW}$	$<80 \text{ nW}$
Agilent N8488A (exclude Option CFT) <sup>3</sup>	$<\pm 3 \text{ nW}$	$<80 \text{ nW}$
Agilent N8481A with Option CFT <sup>3</sup>	$<\pm 7 \text{ nW}$	$<114 \text{ nW}$
Agilent N8481B with Option CFT <sup>3</sup>	$<\pm 7 \mu\text{W}$	$<114 \mu\text{W}$
Agilent N8481H with Option CFT <sup>3</sup>	$<\pm 0.7 \mu\text{W}$	$<11.4 \mu\text{W}$
Agilent N8482A with Option CFT <sup>3</sup>	$<\pm 7 \text{ nW}$	$<114 \text{ nW}$
Agilent N8482B with Option CFT <sup>3</sup>	$<\pm 7 \mu\text{W}$	$<114 \mu\text{W}$
Agilent N8482H with Option CFT <sup>3</sup>	$<\pm 0.7 \mu\text{W}$	$<11.4 \mu\text{W}$
Agilent N8485A with Option CFT <sup>3</sup>	$<\pm 7 \text{ nW}$	$<114 \text{ nW}$
Agilent N8486AR with Option CFT <sup>3</sup>	$<\pm 7 \text{ nW}$	$<114 \text{ nW}$
Agilent N8486AQ with Option CFT <sup>3</sup>	$<\pm 7 \text{ nW}$	$<114 \text{ nW}$
Agilent N8487A with Option CFT <sup>3</sup>	$<\pm 7 \text{ nW}$	$<114 \text{ nW}$

- 1 Within one hour after zero set, at a constant temperature, after a 24-hour warm-up of the power meter.
- 2 The number of averages at 16 (for normal mode) and 32 (for x2 mode), at a constant temperature, measured over a one minute interval and two standard deviations. For Agilent E-Series power sensors, the measurement noise is measured within the low range. Refer to the relevant power sensor manual for further information.
- 3 The zero drift and measurement noise specifications are tested at 50 MHz.

## Settling Time

*0 to 99% settled readings over the GPIB.*

### For Agilent 8480 Series power sensors

*Manual filter, 10 dB decreasing power step:*

**Table 5-4** Settling Time

Number of Averages	1	2	4	8	16	32	64	128	256	512	1024
<b>Settling Time (s)</b> <i>(Normal Mode)</i>	0.15	0.2	0.3	0.5	1.1	1.9	3.4	6.6	13	27	57
<b>Response Time (s)</b> <i>(x2 mode)</i>	0.15	0.18	0.22	0.35	0.55	1.1	1.9	3.5	6.9	14.5	33

*Auto filter, default resolution, 10 dB decreasing power step, normal and x2 speed modes:*

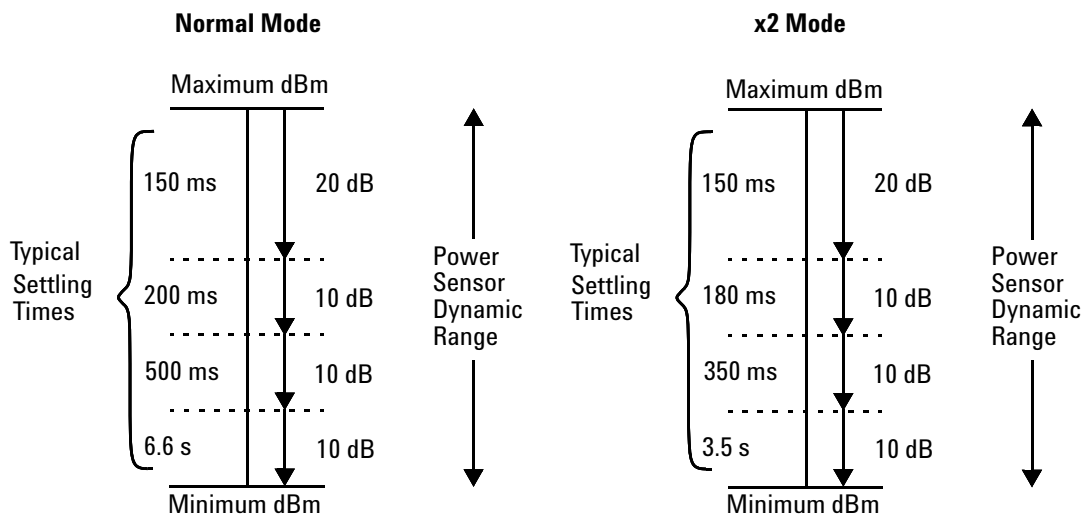

**For Agilent E-Series power sensors**

*In FAST mode, within the range -50 dBm to +17 dBm, for a 10 dB decreasing power step, the settling time is 10 ms<sup>1</sup>.*

<sup>1</sup>*When a decreasing power step crosses the power sensor’s auto-range switch point, add 25 ms. Refer to the relevant power sensor manual for further information.*

*For Agilent E-Series power sensors in normal and x2 speed modes, manual filter, 10 dB decreasing power step:*

**Table 5-5** Settling Time

Number of Averages	1	2	4	8	16	32	64	128	256	512	1024
<b>Settling Time (s)</b> <i>(Normal Mode)</i>	0.07	0.12	0.21	0.4	1	1.8	3.3	6.5	13	27	57
<b>Response Time (s)</b> <i>(x2 mode)</i>	0.04	0.07	0.12	0.21	0.4	1	1.8	3.4	6.8	14.2	32

*Auto filter, default resolution, 10 dB decreasing power step, normal and x2 speed modes:*

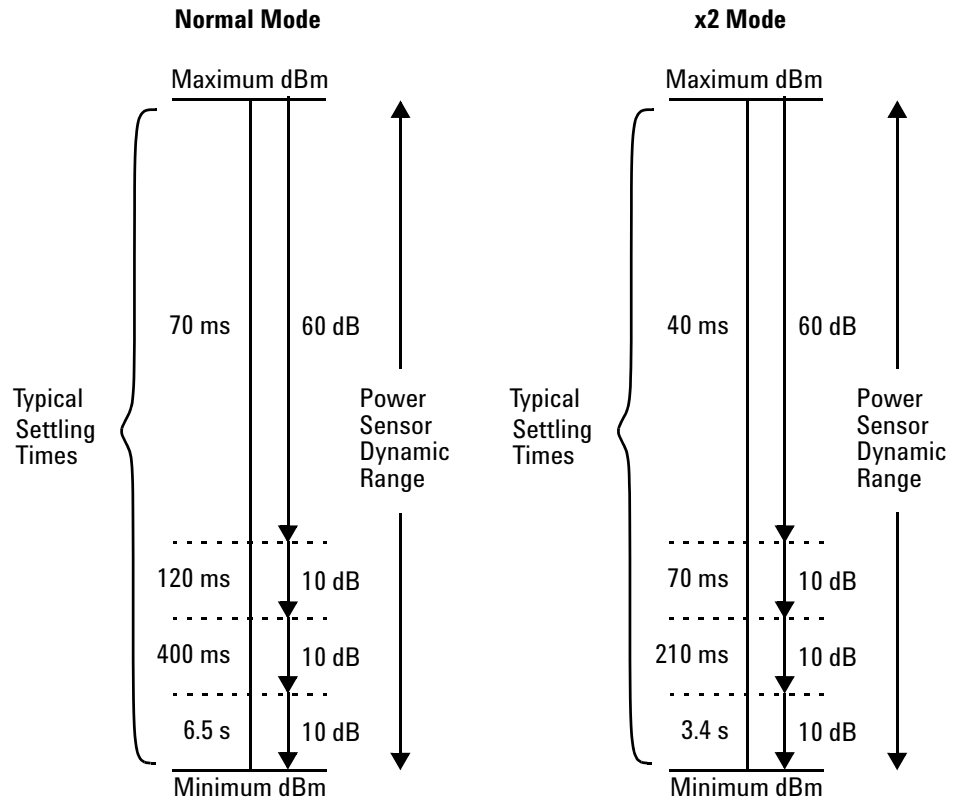

**For Agilent N8480 Series power sensors**

*Manual filter, 10 dB decreasing power step:*

**Table 5-6** Settling Time

Number of Averages	1	2	4	8	16	32	64	128	256	512	1024
<b>Settling Time (s)</b> <i>(Normal Mode)</i>	0.15	0.2	0.3	0.5	1.1	1.9	3.4	6.6	13	27	57
<b>Response Time (s)</b> <i>(x2 mode)</i>	0.15	0.18	0.22	0.35	0.55	1.1	1.9	3.5	6.9	14.5	33

*Auto filter, default resolution, 10 dB decreasing power step, normal and x2 speed modes:*

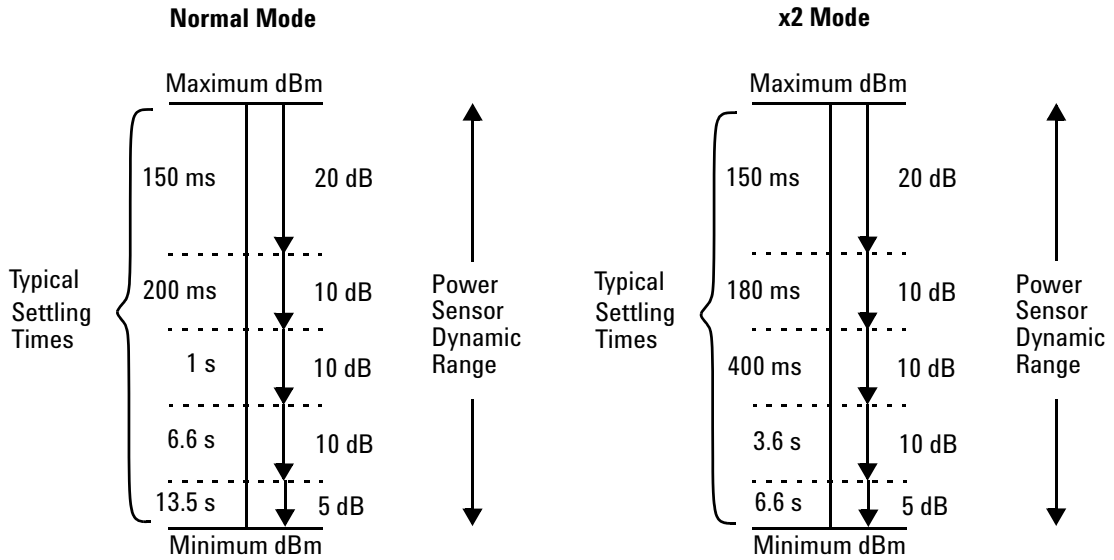



## Power Sensor Specifications

### Definitions

#### Zero Set

In any power measurement, the power meter must initially be set to zero with no power applied to the power sensor. Zero setting is accomplished within the power meter by digitally correcting for residual offsets.

#### Zero Drift

This parameter is also called long term stability and is the change in the power meter indication over a long time (usually one hour) for a constant input power at a constant temperature, after a defined warm-up interval.

#### Measurement Noise

This parameter is also known as short term stability and is specified as the change in the power meter indication over a short time interval (usually one minute) for a constant input power at a constant temperature.

## Battery Option 001 Operational Characteristics

The following information describes characteristic performance based at a temperature of 25 °C unless otherwise noted. Characteristics describe product performance that is useful in the application of the product, but is not covered by the product warranty.

### Typical Operating Time

Up to three hours with LED backlight on; up to five hours with LED backlight off.

### Charge Time

Less than two hours to charge fully from an empty state: 50 minutes charging enables one hour of operation with LED backlight ON; 35 minutes charging enables one hour of operation with the LED backlight OFF. Power meter is operational while it is charging.

### Service Life

To 70% of initial capacity at 25 °C: approximately 450 charge or discharge cycles.

### Chemistry

Nickel Metal Hydride.

### Weight

1 kg.

## General Characteristics

### Rear Panel Connectors

#### Recorder Output

*Analog 0 to 1 Volt, 1 kW output impedance, BNC connector.*

#### GPIB

*Allows communication with an external GPIB controller.*

#### RS-232/422

*Allows communication with an external RS-232 or RS422 controller. Male Plug 9 position D-subminiature connector.*

#### Remote Input/Output

*A TTL logic level is output when the measurement exceeds a predetermined limit. TTL inputs are provided to initiate zero and calibration cycles. RJ-45 series shielded modular jack assembly.*

*TTL output: high = 4.8 V max; low = 0.2 V max*

*TTL input: high = 3.5 V min, 5 V max; low = 1 V max, -0.3 V min*

#### Ground

*Binding post, accepts 4 mm plug or bare wire connection.*

#### Line Power

- **Input Voltage Range:** 85 to 264 Vac, automatic selection
- **Input Frequency Range:** 50 to 440 Hz
- **Power Requirement:** approximately 50 VA (14 Watts)

## Environmental Characteristics

### General Conditions

*Complies with the requirements of the EMC Directive 89/336/EEC. This includes Generic Immunity Standard EN 50082- 1: 1992 and Radiated Interference Standard EN 55011:1991/CISPR11:1990, Group 1 - Class A.*

### Operating Environment

#### Temperature

*0 °C to 55 °C*

#### Maximum Humidity

*95% at 40 °C (non- condensing)*

#### Minimum Humidity

*15% at 40 °C (non- condensing)*

#### Maximum Altitude

*3000 meters (9840 feet)*

### Storage Conditions

#### Storage Temperature

*-20 °C to +70 °C*

#### Non-Operating Maximum Humidity

*90% at 65 °C (non- condensing)*

#### Non-Operating Maximum Altitude

*15240 meters (50000 feet)*

# General

## Dimensions

The following dimensions exclude front and rear panel protrusions:  
212.6 mm W x 88.5 mm H x 348.3 mm D (8.5 in x 3.5 in x 13.7 in)

## Weight

### Net

4.0 Kg (8.8 lb), 5.0 Kg (11 lb) with Option 001

### Shipping

7.9 Kg (17.4 lb), 8.9 Kg (19.6 lb) with Option 001

## Safety

Conforms to the following Product Specifications:

- EN61010-1: 1993/IEC 1010-1:1990+A1/CSA C22.2 No. 1010-1:1993
- EN60825-1: 1994/IEC 825-1: 1993 Class 1
- Low Voltage Directive 72/23/EEC

## Remote Programming

### Interface

GPIB interface operates to IEEE 488.2. RS-232 and RS-422 interfaces are supplied as standard.

### Command Language

SCPI standard interface commands. Agilent 437B code compatible.

### GPIB Compatibility

SH1, AH1, T6, TE0, L4, LE0, SR1, RL1, PP1, DC1, DT1, C0

## Nonvolatile Memory

### Battery

Lithium Polycarbon Monoflouride, approximate lifetime 5 years at 25 °C.

**www.agilent.com**

### **Contact us**

To obtain service, warranty, or technical support assistance, contact us at the following phone numbers:

United States:

(tel) 800 829 4444 (fax) 800 829 4433

Canada:

(tel) 877 894 4414 (fax) 800 746 4866

China:

(tel) 800 810 0189 (fax) 800 820 2816

Europe:

(tel) 31 20 547 2111

Japan:

(tel) (81) 426 56 7832 (fax) (81) 426 56 7840

Korea:

(tel) (080) 769 0800 (fax) (080) 769 0900

Latin America:

(tel) (305) 269 7500

Taiwan:

(tel) 0800 047 866 (fax) 0800 286 331

Other Asia Pacific Countries:

(tel) (65) 6375 8100 (fax) (65) 6755 0042

Or visit Agilent World Wide Web at:

[www.agilent.com/find/assist](http://www.agilent.com/find/assist)

Product specifications and descriptions in this document are subject to change without notice. Always refer to the Agilent Web site for the latest revision.

© Agilent Technologies, Inc. 1998–2013

Printed in Malaysia  
Eighth Edition, April 5, 2013

E4418-90032



**Agilent Technologies**